

City of Santa Clara
Parks & Recreation Department
Park Amenity & Design Standards

The City of Santa Clara Parks & Recreation design standards were developed by the Department of Parks & Recreation. The goal of the design standards is to identify the elements that are consistently found in the City of Santa Clara park system and to provide standard guidance to landscape architects, grounds maintenance staff and others as to what is acceptable. These standards will cover a wide range of park elements, identifying specific product types, materials and installation practices.

It is understood that City park sites should be easily accessible to the public by various modes of transportation: vehicular, bicycle, and pedestrian. Current Federal ADA accessibility guidelines must be incorporated into the design of parks, park facilities and amenities. ADA accessibility should be accommodated at all sites to the fullest extent practical. It is also understood that all new park facilities, elements and components must conform to the most recent uniform building codes, California laws, regulations and safety guidelines. Finally, where applicable, all current City ordinances, Public Works standards and Utilities standards will be followed. Such guidelines are published elsewhere.

The production of the City Park standards meets the following three objectives:

- The use of easily maintained, safe and consistent components implemented city wide.
- A document that clearly represents the City's standard parks components.
- Park facilities and amenities that incorporate the City's branding initiative.

Each section (chapter) may include text, images, and detail to clearly communicate the City's Park standards. Substitutions of equipment or materials may be allowed upon approval by the Director of Parks and Recreation or his/her designee. Information in this document is not intended to replace or function as project specifications, construction documents, or contract documents. Construction plans and contract scope of service shall include all necessary details and specifications.

The design standards include:

- Chapter 1—Standard Park Amenities
- Chapter 2—Irrigation
- Chapter 3—Plant Palette
- Chapter 4—Ball Fields
- Chapter 5—Playgrounds
- Chapter 6—Play Courts (In progress)
- Chapter 7—Miscellaneous (In progress)
- Chapter 8—New Public Park Design, Review & Approval Process

These standards may be superseded at any time by publication of new standards.

For further information or guidance, please contact:

City of Santa Clara
Parks & Recreation Department
1500 Warburton Avenue
Santa Clara CA 95050
(408) 615-2260

Chapter 1 – Standard Park Amenities

Section 1—BARBEQUE GRILLS

1. DEFINITION
 - A. The purpose of this guideline is to establish minimum standards for barbeque grills and their installation.

2. STANDARD
 - A. One individual barbecue is required per two picnic tables.
 - B. A group size barbecue can be shared by four picnic tables.

3. ACCESSIBILITY
 - A. All barbecues shall be accessible to persons with disabilities.

4. APPLICATION
 - A. This section includes the following:
 - 1) Barbeque Grill Type
 - 2) Manufacturer
 - 3) Installation

5. SMALL BARBEQUE GRILL – NEIGHBORHOOD PARKS
 - A. The manufacturer: Kay Park Recreation Corporation.
 - B. Pedestal Grill—product number SB16NP. No substitutions are allowed.
 - C. Installation—poured in place concrete footing. The Pedestal Grill has a 20 x 15 inch grill surface. The depth of the hole must be 30 inches and the diameter 10 inches. Installation method and technique shall be according to the manufacturer’s guidelines.

6. LARGE BARBEQUE GRILL – NEIGHBORHOOD PARKS
 - A. The manufacturer: Kay Park Recreation Corporation.
 - B. Surface Mount Grill—Product number SPD450IG. The Surface Mount Grill has a 38 x 36 inch grill surface. No substitutions may be allowed without written approval by the Director of Parks & Recreation or his/her designee.
 - C. Installation—poured in place concrete footing. The depth of the hole must be 24 inches with an 18 inch diameter. Installation method and technique shall be according to the manufacturer’s guidelines.

Section 2 – DRINKING FOUNTAINS

1. DEFINITION

- A. The purpose of this guideline is to establish minimum standards for drinking fountains and their installation.

2. APPLICATION

- A. This section includes the following:

- 1) Manufacturer
- 2) Water Fountain Type
- 3) Installation

- B. Wall Mounted Drinking Fountain

- C. The manufacturer:

- 1) Haws Corporation
- 2) Dual height wall mounted, 14-gauge stainless steel drinking fountain with No. 4 satin finish. Product Number: 1119.14. Substitutions may be allowed upon approval by the Director of Parks & Recreation or his/her designee.
- 3) Installation method and technique shall be according to the manufacturer's guidelines.

- D. Pedestal Drinking Fountain with bottle filling station

- 1) The manufacturer: Elkay
- 2) Pedestal drinking fountain with bottle filling station, stainless steel contoured basin and standard evergreen powder coated galvanized steel pedestal. Option with pet fountain station available. Product Number: LK4420BF1UDB EZH2O. Substitutions of color may be allowed upon approval by the Director of Parks & Recreation or his/her designee.
- 3) Installation method and technique shall be according to the manufacturer's guidelines.

3. FEATURES

- A. ADA accessible
- B. Dual height

Section 3 - PARK BENCHES & PICNIC TABLES

1. DEFINITION

- A. The purpose of this guideline is to establish minimum standards for park benches, picnic tables, and their installation.

2. STANDARD

- A. Benches are required at playgrounds to person with disabilities.

3. ACCESSIBILITY

- A. All benches shall be accessible to person with disabilities.

4. APPLICATION

- A. This section includes the following:

- 1) Manufacturer
- 2) Park Bench Type
- 3) Installation

- B. Park Bench—with back support

- 1) The manufacturer: DuMOR Incorporated
- 2) Heavy duty bench with back support and two arm rests. Product Number: Bench 58. Substitutions may be allowed upon approval by the Director of Parks & Recreation or his/her designee. (must stipulate 6' or 8' option)
- 3) Installation method and technique shall be according to the manufacturer's guidelines.

- C. Park Bench—backless

- 1) The manufacturer: Dumor Incorporated
- 2) Heavy duty bench without back support or arm rests. Product Number: Bench 92. Substitutions may be allowed upon approval by the Director of Parks & Recreation or his/her designee. (must stipulate 6' or 8' option.)
- 3) Installation method and technique shall be according to the manufacturer's guidelines.

- D. Picnic Tables (Round)—ADA Accessible and with Game Board Option

- 1) The manufacturer: Quick Crete Products Corp.
- 2) Round Precast concrete picnic tables with beveled edges. Tables are ADA accessible. Product Number: examples include, QR42FC, QR42FC3. Substitutions may be allowed upon approval by the Director of Parks & Recreation or his/her designee.
- 3) Installation method and technique shall be according to the manufacturer's guidelines.

- E. Picnic Tables (Square or Rectangular)—ADA Accessible with Game Board Option

- 1) The manufacturer: Quick Crete Products Corp.
- 2) Rectangular Precast concrete picnic tables with beveled edges. Tables are ADA accessible. Product Number: examples include, QLBT72PT, QS42FC3. Substitutions may be allowed upon approval by the Director of Parks & Recreation or his/her designee.
- 3) Installation method and technique shall be according to the manufacturer's guidelines.

Section 4 – PARK RESTROOMS

1. DEFINITION

- A. The purpose of this guideline is to establish minimum standards for park restrooms. The Restroom building shall be custom designed and built at the designated park site to serve the specific program needs of the particular site.

2. STANDARD

- A. Restrooms are required to serve persons with disabilities.
- B. The number of fixtures will typically follow the plumbing code once an occupant load of the park and programmed facilities has been calculated; this may be required at plan check. If a formal occupancy load has not been calculated for the park, or for programmed and informal areas of a park, such as unspecified multi-use or general use athletic fields, then a minimum of three toilets/urinals per gender for up to two (2) athletic fields is necessary. If the facility is a multi-field sports complex with 3 or more fields, then the number required may be increased to fully serve the intended load/capacity of the facility.
- C. Restroom Standard Loads/Fixtures

Male Occupancy	Quantity of water closet(s) & urinal(s)	Female Occupancy	Quantity of water closet(s)
1-100	1+1	1-25	1
		26-50	2
		51-100	3
101-200	2+2	101-200	4
201-400	3+3	201-300	6
		301-400	8
400+	1 fixture each per 500 additional	400+	Add 1 fixture per 125 additional

3. APPLICATION

- A. This section includes the following by fixture:
- 1) Manufacturer
 - 2) Fixture type
 - 3) Installation

- B. Toilet
 - 1) The manufacturer: American Standard Inc.
 - 2) AFWALL FloWise Elongated Flushometer Toilet. Product Number: 2257.001. High efficiency low consumption toilet. Operated from 1.1gpf to 1.6gpf. Substitutions may be allowed upon approval by the Director of Parks & Recreation or his/her designee.
 - 3) Installation method and technique shall be according to the manufacturer's guidelines.
- C. Flushometer
 - 1) The manufacturer: Sloan
 - 2) Flush valve for AFWALL FloWise Elongated Flushometer Toilet. Product Number: G2 Optima Plus. Substitutions may be allowed if flush valve is fully compatible with the specified toilet and upon approval by the Director of Parks & Recreation or his/her designee.
 - 3) Installation method and technique shall be according to the manufacturer's guidelines.
- D. Urinal
 - 1) The manufacturer: American Standard Inc.
 - 2) WASHBROOK FloWise Universal Urinal. Product Number: 6590.001. Ultra high efficiency low consumption urinal. Operated from 0.125gpf to 1.0gpf. Substitutions may be allowed upon approval by the Director of Parks & Recreation or his/her designee.
 - 3) Installation method and technique shall be according to the manufacturer's guidelines.
- E. Urinal Flushometer.
 - 1) The manufacturer: Sloan.
 - 2) ECOS Single Flush and Dual Flush Flushometer. Substitutions may be allowed if flush valve is fully compatible with the specified toilet and upon approval by the Director of Parks & Recreation or his/her designee.
 - 3) Installation method and technique shall be according to the manufacturer's guidelines.
- F. Faucet
 - 1) The manufacturer: Chicago Faucets Inc.
 - 2) HyTronic Contemporary Sink Faucet with Dual Beam Infrared Sensor. Product Number: 116.212.AB.1. Single-hole contemporary electronic integral spout 0.5gpm. Substitutions may be allowed upon approval by the Director of Parks & Recreation or his/her designee.
 - 3) Installation method and technique shall be according to the manufacturer's guidelines.
- G. Sink/Lavatory
 - 1) The manufacturer: American Standard.
 - 2) Lucerne Wall Hung Lavatory. Product Number: 0356.041. Single Center faucet hole. D shaped bowl, wall hung sink. Substitutions may be allowed upon approval by the Director of Parks & Recreation or his/her designee.
 - 3) Installation method and technique shall be according to the manufacturer's guidelines.
- H. Partitions
 - 1) The manufacturer: Bradley Corporation.
 - 2) Floor Mounted Overhead Braced Restroom Partitions. Product Number: Series 400 Sentinel. Options include stainless steel wrap around gravity hinge, stainless steel concealed slide latch, and continuous steel brackets. Substitutions may be allowed upon approval by the Director of Parks & Recreation or his/her designee.
 - 3) Installation method and technique shall be according to the manufacturer's guidelines.

- I. Grab Bar
 - 1) The manufacturer: BOBRICK Washroom Equipment.
 - 2) 1.5 inch Diameter Stainless Steel Grab Bar with Snap Flange. Product Number: Series B-6806 Satin Finish. Placement and angle to be determined by Architect. Substitutions may be allowed upon approval by the Director of Parks & Recreation or his/her designee.
 - 3) Installation method and technique shall be according to the manufacturer's guidelines.
- J. Mirrors
 - 1) The manufacturer: BOBRICK Washroom Equipment.
 - 2) Mirror with Stainless Steel Channel Frame. Product Number: Series B-1656. Tempered Glass 24 x 36 inch mirror. Substitutions may be allowed upon approval by the Director of Parks & Recreation or his/her designee.
 - 3) Installation method and technique shall be according to the manufacturer's guidelines.

Section 5 – TRASH CANS

1. FEATURES

- A. All trash receptacles shall be accessible to persons with disabilities and located immediately adjacent to an accessible path of travel.

2. STANDARD

- A. Sufficient number of trash receptacles shall be provided to serve the users of the park along the path of travel and/or a convenient distance from a major park amenity, but no less than one for each park.
- B. Manufacturer:
 - 1) DuMor Site Furnishings
 - 2) 32 gallon all steel design with optional steel shield and polyester powder finish in Black. Product Number: 102-32SH. Substitutions of color may be allowed upon approval by the Director of Parks & Recreation or his/her designee.

3. INSTALLATION

- A. At least one trash receptacle shall be located within convenient proximity of each:
 - 1) Park building including community center and/or restroom.
 - 2) Picnic area
 - 3) Playground area
 - 4) Athletic fields and sports courts
 - 5) Entry into the park from the parking area

4. Dog Waste Bag Dispenser

- A. At Santa Clara City parks larger than 1.0 acre at least one dog waste bag dispenser station should be installed at appropriate location(s).
- B. Additional signage may be required on the reverse side of the station's Post (meaning two signs with varying message may be required.)
- C. City to determine appropriate language on signs, multilingual if necessary, including citation of City Code sections pertaining to leash law, nuisance animals and others as required by City Parks & Recreation.
- D. Dog waste bag dispenser stations should be installed at the entrances of off leash dog areas
- E. Manufacturer:
 - 1) Dogipot
 - 2) Free Standing 10 gal., bag dispenser, covered waste receptacle in a green smooth finish. Model #1003-L
 - 3) Material for bag dispenser shall be metal.
 - 4) 8 ft. telescopic post set in concrete.

5. Alternate in-ground trash receptacle.

- a) Will be specified by the City **where and** when required. Sybertech Waste Reduction Ltd. One piece polyethylene container-no leach in or out, 300 gallon Capacity, 8 foot tall, 30 inch diameter cylinder buried into the ground 5 feet. Product Number Millennium 3000.

DOGIPOT® TELESCOPING POST® PET STATION (ITEM #1301-P)

SPECIFICATION, INSTALLATION AND OPERATION SHEET

(A) DOGIPOT® PET SIGN (ITEM #1203 / 1204)

- H: 18" x W: 11.5"
- 14 gauge reflective aluminum
- Weight: 1.35 lbs.
- Forest green on white

(B) ALUMINUM DOGIPOT® JUNIOR BAG DISPENSER (ITEM #1002-2)

- H: 15.5" x W: 9.4" x D: 3.25"
- 12 gauge powder coated forest green aluminum
- Weight: 7 lbs.
- 400 bag capacity
- Two diamond shaped bag dispenser slots
- Front locking access panel
- Clearly posted instructions

(C) STEEL TRASH RECEPTACLE WITH LID (ITEM #1206-L)

- H: 23" x 11.5" diameter
- 16 gauge powder coated forest green steel
- Weight: 14.6 lbs.
- 10 gallon capacity with interior trash liner bag
- Attached stainless steel hinged lid
- One (1) box 50 count DOGIPOT® Smart Liner Trash Bags™ #1404 included (5 lbs.)

(D) TELESCOPIC GALVANIZED STEEL MOUNTING POST (ITEM #1301-P)

- 2" x 2" x 8'
- 11 gauge galvanized steel
- Weight: 15 lbs.

TOTAL HEIGHT FROM ABOVE GROUND:

- 6'.6"

SPACE BETWEEN DISPENSER AND SIGN:

- 1.0"

SPACE BETWEEN RECEPTACLE AND DISPENSER:

- 12.5"

SPACE BETWEEN GROUND AND RECEPTACLE:

- 8.0"

HOLE:

- D: 18.0" x W: 8.0"
- Fill with 40 lbs. "ready to use" cement

TOTAL SHIP WEIGHT: 45 LBS.

(MOUNTING HARDWARE INCLUDED)

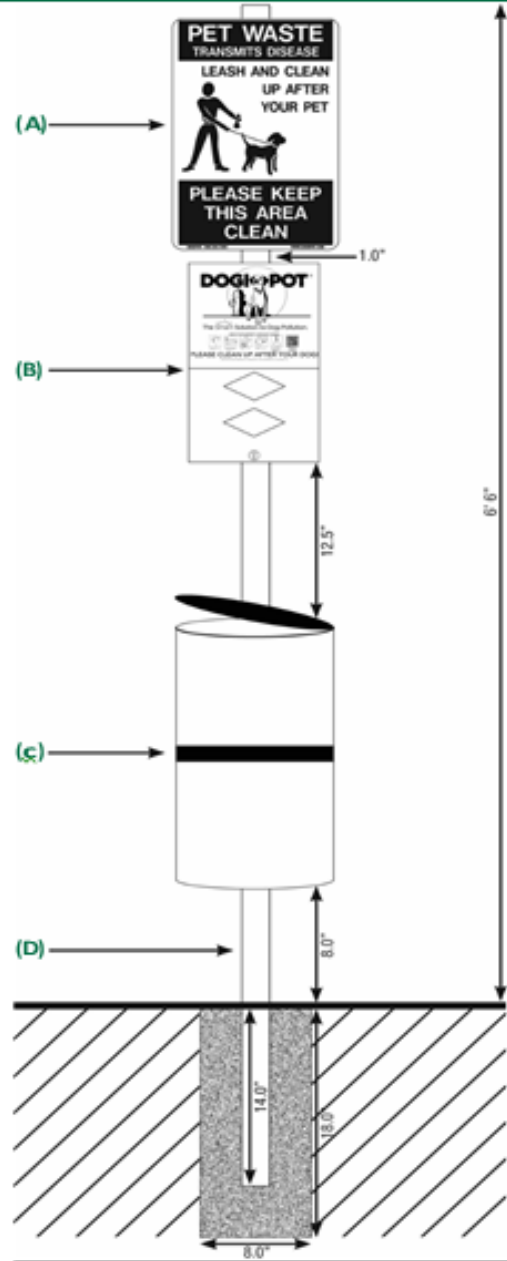

REVISIONS		
REV.	DESCRIPTION	DATE
---	---	---

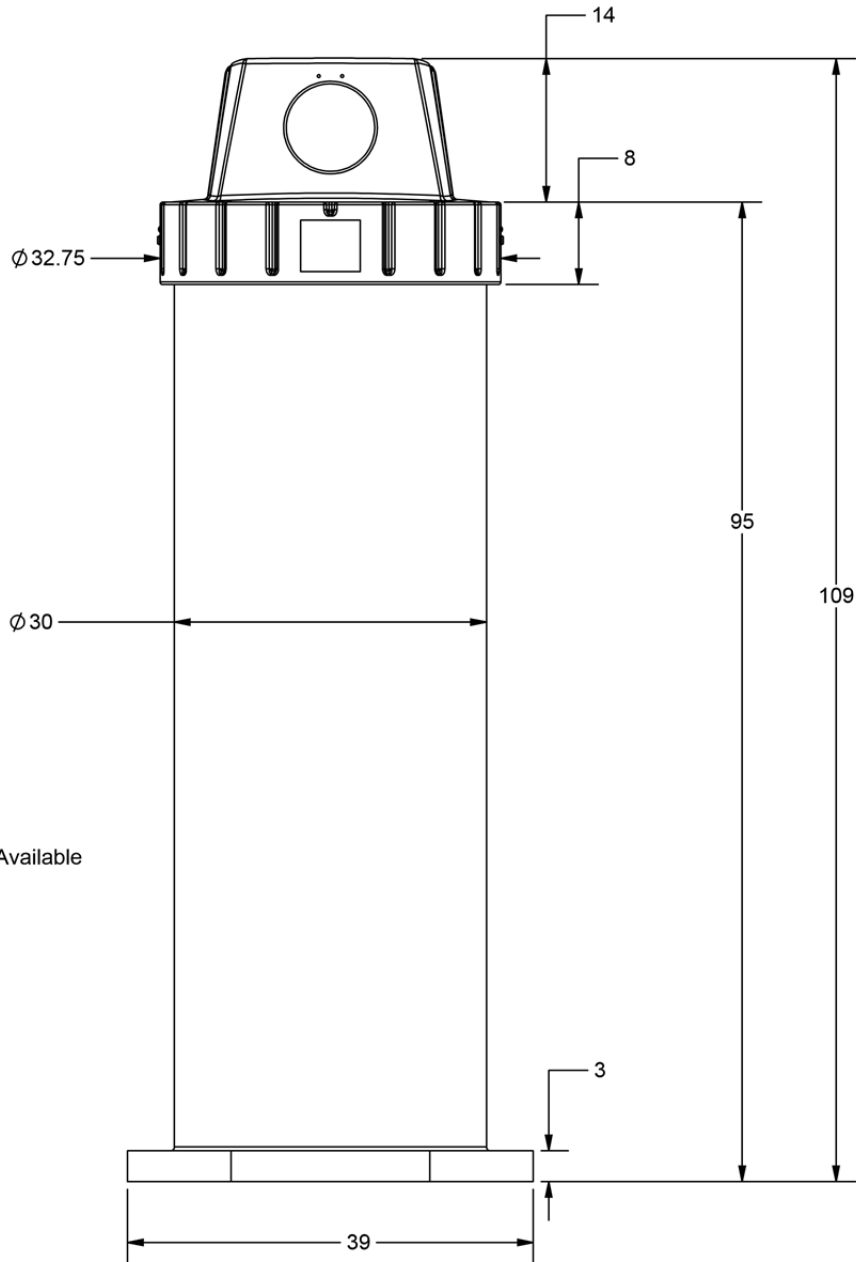

Different Colour Option Available

DIMENSIONS ARE IN INCHES
ALL TOLERANCES ARE:

+/- 1.5%



Sybertech Waste Reduction Ltd.
13698 Coldicutt Avenue
White Rock, BC Canada
V4B 3A9

Millenium 3000 With Ribbed Lid

SIZE DWG. NO.
A

SCALE: 1:15 WEIGHT:

SHEET 1 OF 1

PROPRIETARY AND CONFIDENTIAL
TO SYBERTECH WASTE REDUCTION LIMITED

MATERIAL

Polyethylene

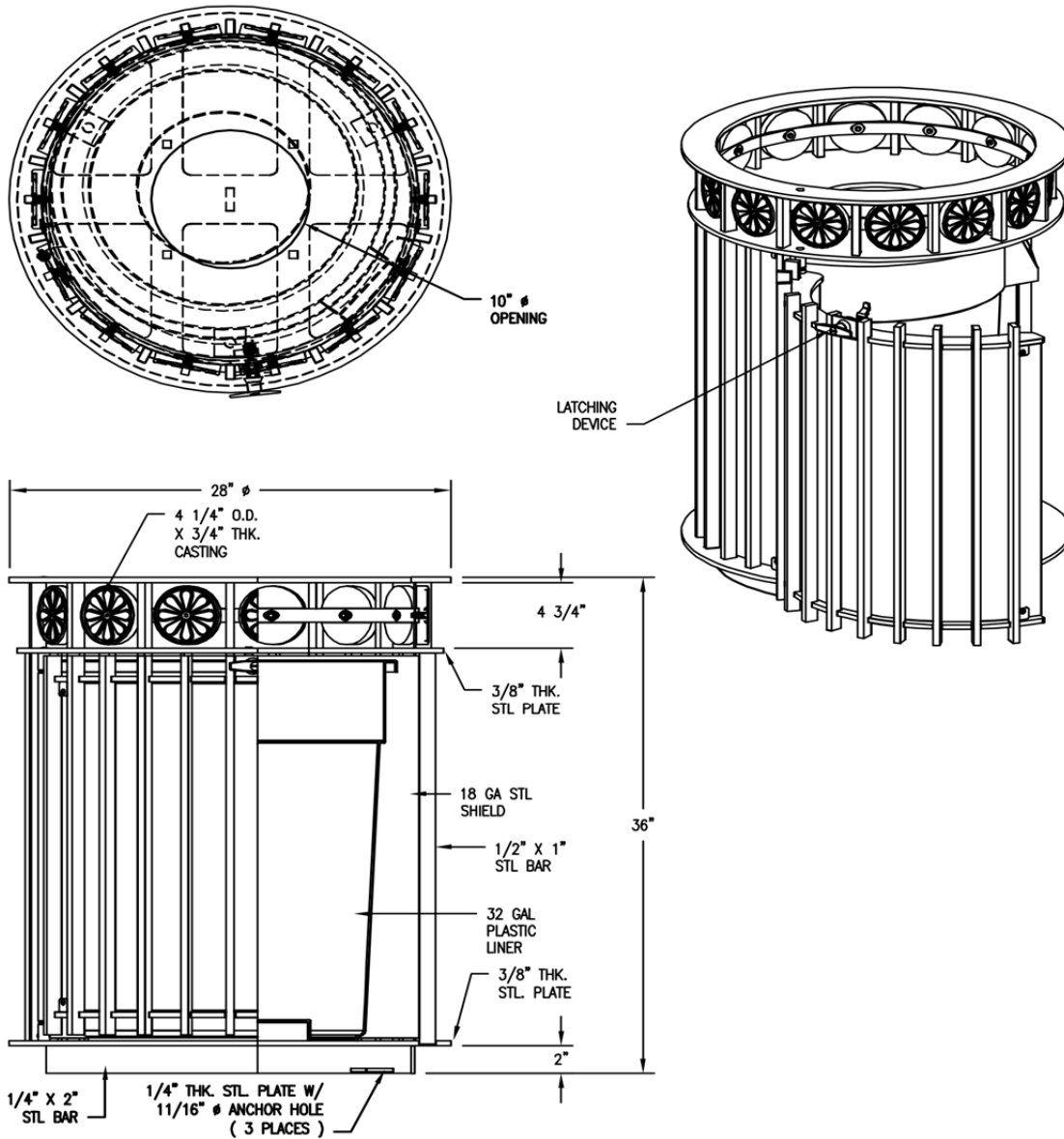

NOTES:

- 1.) ALL STL. MEMBERS COATED W/ ZINC RICH EPOXY THEN FINISHED W/ POLYESTER POWDER COATING.
- 2.) 1/2" X 3 3/4" EXPANSION ANCHOR BOLTS PROVIDED.
- 3.) SIDE OF RECEPTACLE HINGES OPEN FOR REMOVAL OF LINER.
- 4.) LATCH PROVIDED W/ KEY, USE OF KEY OPTIONAL.
- 5.) RECEPTACLE FULLY ASSEMBLED AT FACTORY.



RECEPTACLE

DATE DRAWN : 12/01/00
 DRAWN BY : HD
 DATE REV. : 8/7/17
 REV. BY : JSB

REV.
F

DRAWING
NUMBER

102-32SH-FTO

SHEET
1 OF 2

NOTES:

- 1.) DURING ASSEMBLY PROCEDURE;
DO NOT COMPLETELY TIGHTEN HARDWARE.
- 2.) THE ACTUAL PARTS WILL NOT BE NUMBERED.
NUMBERS ONLY APPLY TO DRAWING.
- 3.) UPON COMPLETION OF ASSEMBLY SQUARE
ALL COMPONENTS THEN TIGHTEN ALL HARDWARE.
- 4.) MOUNT AND ANCHOR AS SPECIFIED.

TOOLS REQ'D

- 3/4" WRENCH
- 1/2" MASONRY DRILL BIT
- DRILL

PARTS LIST

ITEM	QTY	PART NO	DESCRIPTION
1	1	0-102-30SH-FTO	30 GAL STL RECEPT ASMBLY W/ FLT TOP
2	1	49-32	32 GAL PL LINER W/ HANDLE, BLK

KITS PROVIDED

ITEM	QTY	PART NO	DESCRIPTION
3	1	K-ANC0860-3	1/2" X 3 3/4" SS ANCHOR KIT (3PCS)

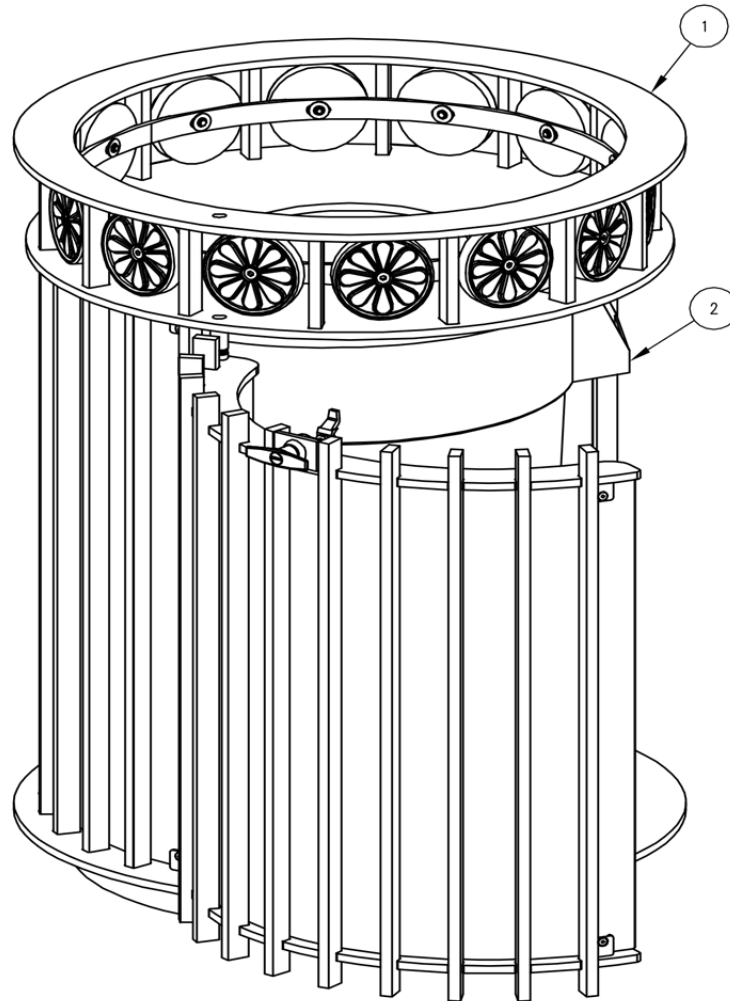

ASSEMBLY
INSTRUCTIONS

DATE DRAWN : 12/01/00
DRAWN BY : HD
DATE REV. : 8/7/17
REV. BY : JSB

REV.
F

DRAWING
NUMBER

102-32SH-FTO

SHEET
2 OF 2

Section 6 – SIGNAGE

1. DEFINITION

- A. The purpose of this guideline is to establish minimum standards for park signage which includes way-finding.
- B. All signs used in public park areas should have a cohesive design theme consistent with City standards and which incorporate current City branding.

2. DESIGN STANDARD

- A. Park signage includes:
 - 1) Directional signs to the public park (way-finding)
 - 2) Entry monument signs that designate the park name. Two alternatives are available:
 - a. Rectangular concrete sign with City seal and inset letters.
 - b. The traditional City Park Sign with brown wood plank with yellow inset letters
 - 3) Directory or way finding sign with map(s)
 - 4) Intra-park directional signage
 - 5) Park amenity signs

3. APPLICATION

- A. The Park name sign and/or monument sign should be visible from multiple angles and associated with public access from public right of way near a major intersection or point of access and have visual prominence.
- B. The park name sign must not be obscured by plants or utility boxes.
- C. The City seal is required to be on the park name sign and/or the entry monument sign.
- D. Any use of the City seal must be approved in advance by the City Manager's Office.
- E. Coordinate an inspection date & time with Deputy Parks & Recreation Director. Inspection to be conducted by Deputy Parks & Recreation Director, or designee.
 - 1) Review accuracy of construction
 - 2) Do not proceed with the work until unsatisfactory conditions have been corrected.

4. QUALITY ASSURANCE

- A. Information herein contained indicates the types of materials and the quality of workmanship full compliance with the established City signage standard.
- B. The work covered under this section includes supplying and installing all materials and equipment required for park signage.

5. MATERIALS

- A. Concrete sign (see Attachment 1.0)
- B. Manufacture: Quick Crete
- C. Beveled on all eight (8) edges above monument base.
- D. 30"h, 96"w, 6"d

- 1) Emblem 11" diameter affixed with vandal proof screw in center.
 - a. Park sign letters 6"h recessed 1/2"
 - b. City letters 3.25"h recessed 1/4"
 - c. Recessed field area 1/2" deep
 - d. Border top, right side, bottom 2"
 - e. Border at city emblem 20"w, 16" h
 - f. Two holes @ 56" oc equally spaced (28" from center) with threaded acme nut embedded into concrete top and bottom for lifting eye on top and anchor rod on bottom.
 - g. Finish smooth top, sides and bottom, sign field is a light exposed aggregate.
 - h. Back of sign is sanded finish.
 - i. All edges are have a finished radius 3/8"
 - j. Contact City for current fonts to match current City branding and logos.
 - k. Sign base 12" h, 84"w, 12"d
 - l. Mow band 36"d, 108"w
- E. Wood Sign
 - a. Sign board 2x12x96 (1.5x11 nominal)
 - b. Rot resistant wood (cedar, redwood, etc.)
 - c. Corners radius 6"
 - d. Letters all caps 5.5"h
 - e. Posts 6x6x50" (5.5x5.5x60 nominal)
 - f. Top of post chamfered 1" all four edges
 - g. Upper sign mounted 5" from top of post to top edge of sign
 - h. Lower sign mounted 20" from top of post to top edge of sign
 - i. Posts added depth of one inch to accept sign
 - j. Edges of signs radius 1/2" front and back
 - k. Mow band 30" d, 120"w
 - l. Sign surface mounted to H-bracket embedded into concrete
 - m. H-bracket 4"x24"x1/4"
 - n. Sign boards mounted to posts using 4 carriage bolts (3/8" x 5") and the nut is at the back of the post.
 - o. Nut recessed into the post to avoid injuries.
 - p. Bolts should be flush with back of post.
 - q. Posts should be 6' apart and evenly spaced off the center line of the mow band
 - r. Paint Color—Entire sign has to be primed.
 - s. Color of letters—Olympic (a yellow).
 - t. Color of the stain—(Oxford Brown).

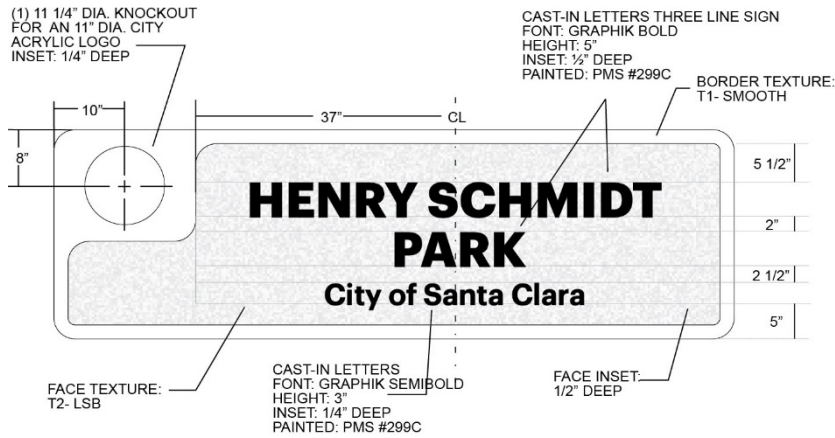

FRONT ELEVATION VIEW THREE LINE SIGN

ALL EDGES TO HAVE 1/4" RADIUS MIN.
MANUFACTURING TOLERANCE +/- 1/4"
PRODUCT: ONE SIDED SIGN (96"L X 30"HT)
CONCRETE COLOR: C1-NATURAL
CONCRETE TEXTURE: SEE BELOW
SEALER: STANDARD GLOSS SEALER

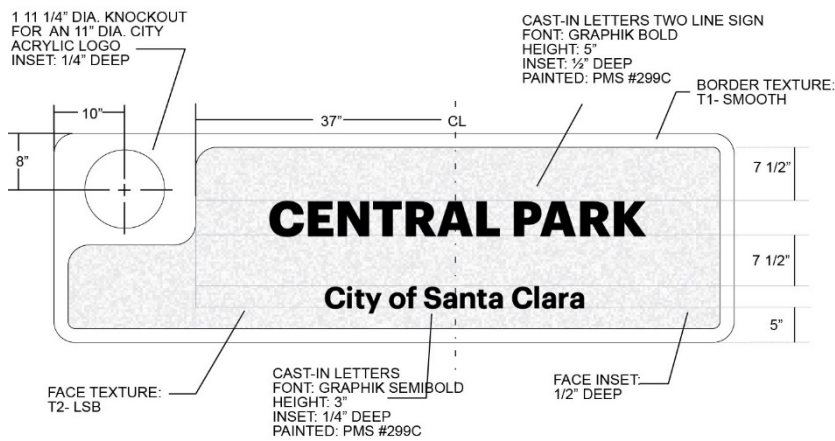

FRONT ELEVATION VIEW TWO LINE SIGN

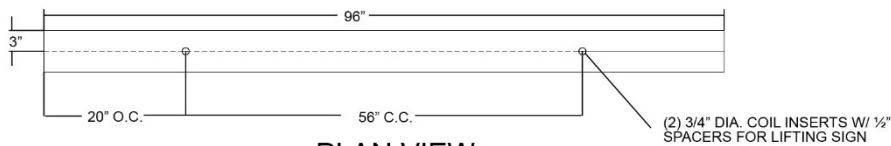

PLAN VIEW

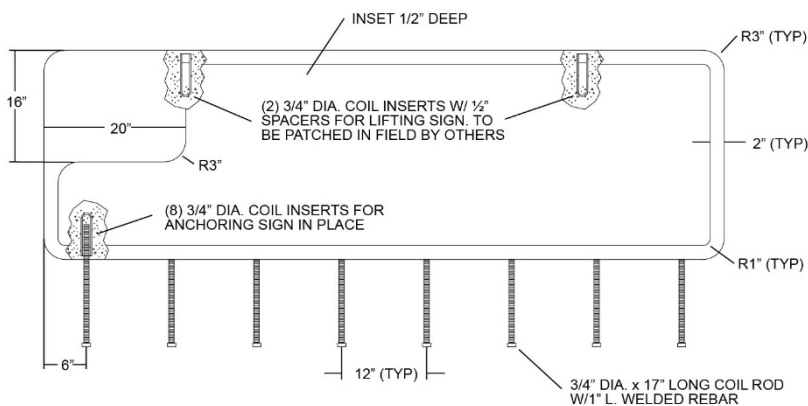

ELEVATION VIEW

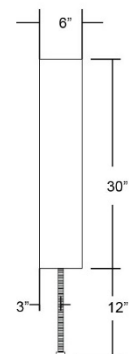

SIDE VIEW

Draft Updated October 2018

Chapter 2 – Irrigation

Section 1—GENERAL IRRIGATION

1. DEFINITION

- A. The purpose of this guideline is to establish minimum standards for general irrigation in parks and park facilities with athletic fields.

2. SCOPE: The Work of this Section shall consist of furnishing all labor, materials, equipment, appliances and services necessary for the execution and completion of all **Irrigation Work** as shown on the Plans and as described in the Standards including, but not necessarily limited to, the following:

- A. Provide complete operating irrigation systems;
- B. Installation of new and refurbishment of existing irrigation systems as necessary to provide complete operating irrigation systems for all planting areas within the Work Limits.
- C. 120 volt electrical service for and connection to the controller.
- D. Irrigation Controller within lockable Controller Enclosure as designated on the Approved Plans.
 - 1) Controller Enclosure Shall be stainless steel, sized to fit the controller and the other electrical components, irrigation controller electrical pedestal shall be stainless steel enclosure, or City approved equal where applicable.
- E. Coordination with Work of other Sections and/or City Inspectors,
- F. Sleeving.
- G. Testing.
- H. Clean-up.
- I. As-Builts by means of Global Positioning System (GPS).
- J. Replacements, Repairs, Guarantees and Warranty Work.

3. STANDARDS

- A. The irrigation design must include a holistic approach to landscape maintenance and management with the aim of conserving water and applying drought control techniques. The preference of irrigation water source should be in the following priority order:
 - 1) Recycled Water (whenever connection to recycled water supply line is available and/or feasible) as per State Regulations.
 - 2) Potable Water
- B. Drip irrigation should be included in the irrigation design wherever and whenever applicable.
- C. The irrigation design must provide for the separation of irrigation zones and sprinkler type based on the water requirements of the plants.
- D. The work covered under this section includes supplying and installing all materials and equipment required for a complete operational automatic irrigation system.

- E. The information herein contained indicates the types of materials and the quality of workmanship to ensure maximum efficacy of the irrigation system.
- F. Completion of work shall mean the full and exact compliance and conformity with all the provisions of the Contract Documents.

4. SUBMITTALS

- A. Provide manufacturer’s product data sheets for each item specified.
- B. Due to maintenance and repair issues, there shall be no substitutions for the materials listed in Parks and Recreation Specifications unless specifically authorized by the Director of Parks and Recreation or a designee.
- C. Product certificates shall be required by manufacturers for products not specifically named on plans, or Parks & Recreation Specifications certifying that each product furnished meets this specification, specifications shown on drawings.
- D. Materials List: Contractor shall submit a complete materials list for approval by the Public Works Landscape Inspector prior to performing any Work. Catalog data and full descriptive literature must be submitted whenever the use of items different than those specified is requested. Notarized certificate must be submitted by plastic pipe and fitting manufacturer indicating that material complies with the Project Specifications, unless material has been previously approved, and used on other projects by City. Material list shall be submitted using the following format:

<u>Item</u>	<u>Description</u>	<u>Manufacturer</u>	<u>Model No.</u>
1	Pressure Supply Line	Lasco	Sch. 40
2	Lawn Head	Rainbird	2400

- E. Provide a one year warranty from the date of Substantial Completion to cover all defective material and workmanship.

5. QUALITY ASSURANCE

- A. Landscape irrigation system installation shall only be performed by a firm that has a minimum of five (5) years full time experience with similar projects in the successful installation of underground landscape irrigation systems. The firm shall be state certified or a licensed subcontractor or a locally registered subcontractor in California. Crews shall be controlled and directed by a foreman who is thoroughly familiar with the type of materials being installed and the manufacturer's recommended methods of installation.
- B. Manufacturer’s Qualifications:
 - 1) Employ only manufacturers with at least five (5) years’ experience making the specified materials as a current catalog and regular production item.

6. DESIGN MODIFICATIONS

- A. Slight layout modifications may be made only as necessary to meet field conditions and only as acceptable to the Landscape Architect or the Architect. Piping shown on drawings is diagrammatically routed for clarity -route to avoid conflict with specimen plants and adjust as necessary to landscape construction.

- B. Design Criteria:
 - 1) The Architect or Landscape Architect shall have the right, at any stage of the operations, to reject any and all work and materials, which, in their opinion, do not comply with the requirements of the Contract Documents. Such rejected work or material shall be immediately removed from the site and acceptable work or material substituted in its place.
 - 2) Contractor shall be responsible for verification at the site of all conditions and dimensions shown on the drawings prior to commencement of work.

7. AS-BUILT DRAWING/CLOSEOUT SUBMITTALS

- A. After completion of piping installation, the Contractor shall furnish to the Architect a reproducible "AS-BUILT" drawing showing all sprinkler heads, valves, and pipelines to reasonable scale, and provide a minimum of two dimensions taken from fixed obvious objects to point of connection, directional turns of all mainline piping, each automatic and manual control valve, and quick coupling valve. The plans shall be provided on or before the date of work review for provisional acceptance. GPS coordinates for each item listed below, shall be noted on the plans and recorded on Compact Disk (CD) in WR format, on an Excel spread sheet to City for approval.
- B. The Contractor shall also furnish a drawing showing a graphic representation of sprinkler zones and recommendations for controller time settings for each valve.
 - 1) Instruction sheets and parts lists covering all operating equipment shall be bound into folders and furnished to the Architect.
 - 2) Backflow preventer test report (passing).
- C. Show locations and depths of the following items:
 - 1) Point of connection, Water Meter and Backflow Assembly. (GPS)
 - 2) Routing of irrigation pressure lines (dimension maximum 100 feet along routing).
 - 3) Irrigation remote control valves, master valves filters, etc. (GPS)
 - 4) Quick coupling valves. (GPS)
 - 5) Routing of control wires.
 - 6) Controllers. (GPS)
 - 7) Flow Meters. (GPS)
 - 8) Related equipment (as may be directed).

8. INSPECTIONS

- A. Inspections will be required for:
 - 1) Pressure test of irrigation main line.
 - 2) System layout.
 - 3) Coverage test.
 - 4) Final inspection/start of maintenance.
 - 5) Final acceptance.
- B. Inspection Requests: Contractor shall notify the Public Works Landscape Inspector a minimum of 48 hours (two working days) in advance for all inspections including the following:
 - 1) Pressure supply line installation and testing
 - 2) System layout
 - 3) Coverage tests
 - 4) Final Inspection

- C. Evidence of Inspection by Others: When inspections have been conducted by other than the Planning Inspector and the respective Parks Division Supervisor, Contractor shall show evidence of when and by whom these inspections were made.
- F. Requirements for Inspection: No inspection is to commence without "record" prints available on the site. In the event Contractor calls for an inspection without up to date "record" prints, without completing previously noted corrections, or without preparing the system for inspection, the inspection may be canceled.
- G. Closing in Un-inspected Work: Do not allow or cause any of the Work of this Section to be covered up or enclosed until it has been inspected, tested and approved by the Public Works Landscape Inspector.
- H. Coverage test: When the irrigation system is completed, Contractor shall perform a coverage test in the presence of the Public Works Landscape Inspector to determine if the water coverage for planting areas is complete and adequate. The Public Works Landscape Inspector and the Parks Division Supervisor must accept this test before planting may commence.
- I. Hydrostatic test:
 - 1) Prior to the installation of any valves, all pressure lines shall be tested under a hydrostatic pressure of 150 psi for a period of not less than two hours. Ball valves and pressure gauges shall be installed at all terminating ends of the mainline and the remainder of all points in between shall be capped and the line fully charged with water after all air has been expelled from the line.
 - 2) All hydrostatic tests shall be made in the presence of the Public Works Landscape Inspector or Inspector's designated representative. No pressure line shall be backfilled until it has been inspected, tested, approved in writing, and the mainline and valve locations have been noted on the "record" prints.
 - 3) Contractor shall furnish the necessary force pump and all other test equipment, and shall perform the test.

9. UTILITIES

- A. Prior to excavation, verify in the field the location and depth of all new and existing utilities including potable and/or recycled water mains, existing irrigation, existing pathway lighting wiring, sewer lines, storm drainage and other work that may be damaged by the Contractor's construction.

10. GUARANTEES

- A. The entire irrigation system, including all Work done under this Contract, shall be guaranteed against all defects and fault of material and workmanship. The Contractor shall furnish warranties, in writing, certifying that the quality and workmanship of all materials and installation furnished is in accordance with the Contract Documents, in accordance with the original manufacturer's warranties.
 - 1) The Contractor shall be responsible for the fulfillment of all manufacturers' warranties.
 - 2) The Contractor shall guarantee materials and workmanship for a period of one year from date of granting Substantial Completion by the City.
 - 3) The Contractor is responsible for protection of the work until the date of Final Completion.

- 4) Should any problem with the irrigation system be discovered within the guarantee period, it shall be corrected by Contractor at no additional expense to City within fourteen (14) calendar days of receipt of written notice from City.

11. MATERIALS

- A. Materials and equipment shall be new and shall operate at the manufacturer's published capacities.
- B. PIPE—Comply with the following unless otherwise indicated:
 - 1) Pressure supply lines 2 inches in diameter and up to 8 inches in diameter shall be either Class 315 solvent weld PVC.
 - 2) Pressure supply lines 1-1/2 inches in diameter and smaller shall be minimum schedule 40 PVC ASTM D-1785.
 - 3) All PVC lateral pipe shall be Schedule 40 ASTM D-1785 Polyvinyl Chloride, Type 1, NSF approved.
 - 4) All irrigation pipes shall be purple in color to prevent potential of cross contamination (potable & recycled waterlines).
 - 5) All crossings (sleeves) under paved areas shall be Schedule 40 PVC, ASTM D-1785.
 - 6) PVC socket fittings shall comply with ASTM D 1785, type 2, IPS, Schedule 40 NSF as manufactured by Sloan Manufacturing Co., or Lasco.

12. TURNOVER ITEMS

- A. Controller Charts
 - 1) "Record" prints must be approved by the Public Works Landscape Inspector before charts are prepared.
 - 2) Provide one controller chart for each automatic controller. The chart shall show the entire area covered by the controller, preferably in a single sheet. The chart shall be a reduced copy of the approved "record" print. Reduce the print to a size that is the maximum dimensions that will fit within the controller door without folding. If the controller sequence is illegible at this reduction scale, the chart may be provided as a "multi-sheet" chart to provide adequate legibility.
 - 3) Each control station on the Chart shall be marked with a different color to show its area of coverage.
 - 4) When completed and approved, the chart shall be hermetically sealed between two pieces of plastic, each piece being minimum 20 mils in thickness. The chart shall be installed in the controller enclosure using Velcro fasteners, and three different color grease pencils (red, black and blue) shall be provided in the enclosure for maintenance notations on the chart.
 - 5) Controller charts shall be completed prior to the final acceptance inspection.
- B. Operation and Maintenance Manuals: Within a minimum of 14 calendar days prior to acceptance of construction, prepare and deliver to the Public Work Landscape Inspector all required descriptive materials, properly prepared in two individually bound copies of the operation and maintenance manual. The manual shall describe the material installed and shall be in sufficient detail to permit operating personnel to identify, operate, and maintain all equipment. Spare parts lists and related manufacturer's information shall be included for each equipment item installed. Each complete, bound manual shall include the following information.

- 1) Index sheet stating Contractor's address and telephone number, including names and addresses and telephone numbers of local manufacturer's representatives.
 - 2) Complete operating and maintenance instructions on all major equipment.
- C. Materials to be furnished: The following items shall be supplied as part of this Contract and shall be turned over to the Public Works Landscape Inspector at the conclusion of the Project at the Final Acceptance Inspection.
- 1) Two (2) special tools/wrenches for disassembly and adjustment of each type of irrigation equipment/heads installed that require such special tools/wrenches.
 - 2) Two keys for each type of automatic controller.
 - 3) One valve box cover key.
 - 4) "Record" prints, CD's and "As-Built" Plans at Final Acceptance.
 - 5) Documentation of Water Department's inspection and acceptance of backflow device.

Section 2—PLANTING IRRIGATION

1. DEFINITION

- A. The purpose of this guideline is to establish minimum standards for planting area irrigation in parks.

2. CONTROLLER WITH REMOTES

- A. Minimum of 2 remotes.
- B. The Contractor shall furnish Rain Bird electric controller for up to 48 zones, Rain Bird ESP-LXMEF electric controller for more than 48 zones or equivalent that is completely compatible and much completely integrate with the IQ v2.0 Modular Multi-site Central Control system as indicated on the drawings and as specified herein.
- C. The controller(s) shall be installed in the area(s) shown on the drawings.
- D. All electrical connections are the responsibility of the Contractor. Materials for electrical service shall comply with the standard specifications, governing utility agency standards, and requirements of all applicable codes. All controllers serving landscape areas that will not being turned over to the City for maintenance shall be powered through a metered electrical service.
- E. A typewritten plastic laminated legend shall be attached inside the controller(s) door stating the areas covered by each remote control valve.
- F. Pressure regulator
 - 1) Wilken
 - 2) Febco
 - 3) Shall be installed on all irrigation lines.
 - 4) Shall have an operating range of 25 PSI to 75 PSI.
- G. Master valve
 - 1) Normally open
 - 2) Rainbird PEB valve
- H. Flow meter
 - 1) Rainbird FS200 B or equivalent
- I. Wiring Installation
 - 1) Four (4)14-1 wires shall be installed in rigid conduit from the P.O.C to the irrigation controller for a Flow Sensor and Master Valve. The wires shall be a continuous run without any junction boxes or splices. They shall be installed in the controller and terminated in a valve box at the P.O.C. There shall be sufficient length of wire to allow easy installation.
 - 2) The wires shall be:
 - One (1) black wire and one (1) red wire, label “Flow Sensor” at the P.O.C. and the controller.
 - One (1) yellow wire and one (1) blue wire, label “Master Valve” at the P.O.C. and controller.

3. SPRINKLER HEADS

- A. Pressure regulating sprinkler heads should be incorporated into irrigation design to maximize water conservation and to reduce output variation between heads.
- B. A minimum of two bubblers shall be placed at each tree location.

C. Recommended manufacturer: Rainbird.

4. RISERS AND SWING JOINTS

- A. Risers shall be schedule 40 pipe, 36", or at anticipated height of plantings. Poly-pipe shall not be used in swing joints.
- B. Swing joints shall be schedule 80 threaded risers with three threaded Marlex fittings.

5. BALL VALVES

- A. Shall be all brass body, or approved equal.

6. ISOLATION VALVE

- A. Valve shall be a ball valve to be placed before valve manifold.

7. REMOTE CONTROL VALVES

- A. Valves shall be Rainbird PEB valves. Use Teflon tape only on threaded connections. Only one valve shall be placed in a single valve box.
- B. Valve shall be installed with threaded elbow or union on mainline side and a union on the lateral side.
- C. Valves shall be installed in shrub areas whenever possible. No valves or valve boxes other than quick coupler valves shall be installed within a designated turf area.

8. QUICK-COUPLING VALVES

- A. Quick coupling valves shall have locking vinyl cover and shall be 1" in size.
- B. Install quick couplers within valve boxes per the Parks & Recreation Department's standards at maximum 75' o.c., and maximum 50' from ends of all planting areas.

9. VALVE BOXES AND TAGS

- A. Valve boxes (bodies and covers) shall be purple in color and shall be 12" x 17" rectangular box installed flush with finish grade. Valve boxes shall be marked "IRRIGATION". Each valve shall have a Christy zone tag inside the valve box.

10. CONTROL WIRING

- A. All wiring to automatic circuit valves shall be UF-14 (14 gauge) UL approved, direct burial wire of a different color than the black and white wires used on the 115 volt AC power. 18 gauge multi-strand wire shall be used from the controller to a wall mounted junction box below the controller and shall be connected to the 14 gauge zone wires.
- B. Wiring from the controller to the valves shall be installed in same trench as the mainline where possible. Where wires are not placed in the trench with the mainline, install in schedule 40 PVC conduit, minimum of 18" below grade.
- C. All wire shall be furnished in minimum 2,500' reels and spliced only at valve or tee locations.

- D. Each valve shall have a second wire to serve as a backup in the event that the first wire becomes comprised.

11. BACKFLOW PREVENTER

- A. Backflow preventer: A backflow preventer shall be installed on all irrigation sprinkler systems. The assembly shall be the same size as the meter and shall be a Watts 909 Reduced Principal Zone (RPZ) mounted on Schedule 80 PVC for 2-inch and less. For larger than 2-inch, the assembly shall be mounted on cemented ductile iron pipe or as required by the Purveyor. The location shall comply with regulatory agencies.

12. SOLVENT CEMENT/SOLVENT & CLEANER

- A. Solvent Cleaner shall meet ASTM A 2546 standards and be all purpose plastic pipe cleaner.

Section 3 –EXECUTION

1. INSPECTION

- A. Contractor must examine the areas and conditions under which landscape irrigation system is to be installed and notify the City of Santa Clara in writing of conditions detrimental to the proper and timely completion of the work.
- B. Coordinate an inspection date & time with Deputy Parks & Recreation Director. Inspection to be conducted by Deputy Parks & Recreation Director, or designee.
 - 1) Review accuracy of construction
 - 2) Do not proceed with the work until unsatisfactory conditions have been corrected.

2. IRRIGATION SYSTEM DESIGN & WATER SUPPLY

- A. The irrigation system design is based upon an available water pressure of p.s.i. at a flow rate of g.p.m. Individual stations are designed to this minimum p.s.i. The system is also designed to withstand a maximum pressure of p.s.i. Contractor shall verify the size of the existing water supply/meter and the existing operating water pressure at the water supply location shown on the Plans prior to starting construction. Contractor shall notify the Public Works Landscape Inspector in writing of any discrepancies noted. Failure to provide such written notification may cause Contractor to provide for modifications to the irrigation system as necessary to provide for a fully operational system providing 100% coverage at the operating pressure available, all at no additional cost to City.
- B. Connection to, or the installation of, the water supply shall be at the location shown on the Plans. Minor changes caused by actual site conditions shall be made at no additional cost to City.

3. COORDINATION

- A. Crossings (sleeves) under paved areas (such as sidewalks, roadways and parking lots) as indicated, shall be installed by the Contractor.
- B. Crossings shall be installed prior to construction of paving.
- C. The Contractor shall be responsible for coordinating work with all other parties involved with the project, and shall coordinate the supply of electrical power to the Timing Device (controller) and tie-in into grounding system.
- D. The Contractor shall be responsible for full and complete coverage of all irrigated areas and shall make any necessary minor adjustments at no additional cost to the City of Santa Clara.

4. EXCAVATING AND TRENCHING

- A. Perform all excavations as required for the installation of the work included under this section, including shoring of earth banks to prevent cave-ins. Where major root systems of large existing trees are encountered, including roots 4" diameter or larger, tunnel to avoid cutting the roots. Underground Service Alert (USA) shall be done prior to excavation and trenching. Contractor is responsible for all damage due to improper work safety techniques or no USA.
- B. Restore all surfaces, existing underground installations, damaged or cut as a result of the excavations to their original conditions.

- C. Trenches for pipelines shall be made of sufficient depth to provide the minimum cover from finish grade as follows.
 - 1) 24" minimum cover over main lines.
 - 2) 24" minimum cover over control wires.
 - 3) 18" minimum cover over lateral lines to heads.
- D. Make all necessary measurements in the field to ensure precise fit of items in accordance with the original design. Contractor shall coordinate the installation of all irrigation materials with all other Work. Special attention shall be given to coordination of piping locations versus tree and shrub locations and sleeve locations versus pavement installation to avoid conflicts.
- E. Keep trenches free of obstruction and debris. Remove excess soil from the site and leave grade as it was prior to irrigation system installation.
- F. Piping shall be routed around shrubs, trees and other permanent obstacles.
- G. Permanent Resurfacing shall be all surface improvements damaged or removed as a result of Contractor's operations shall be reconstructed by Contractor to the same dimensions, except for pavement thickness, and with the same type materials used in the original Work. Trench resurfacing shall be 1 inch greater in thickness than existing pavement. Concrete pavement shall be removed and replaced in "full panels" with no horizontal dimension less than five (5) feet. Contractor shall review the planned limits and lines of concrete removal and replacement with the Parks & Recreation designee prior to saw cutting for Removal Work.

5. GRADES

- A. Contractor is to keep within the specified material depths with respect to finish grade. Failure to obtain specified material depths may subject Contractor to adjusting the grades or depth of lines until acceptable depths of cover are achieved, all as directed by the Parks & Recreation designee and at no additional cost to City.

6. PIPE LINE ASSEMBLY

- A. Install plastic pipe as recommended by the manufacturer and provide for expansion and contraction. Cut plastic pipe square. Remove burrs at cut ends prior to installation so that a smooth unobstructed flow will be obtained. Provide continuous support of the pipe using an unobstructed even trench bottom that is free of debris.
- B. Install remote control valves at locations no closer than 12" to weld edges, buildings, and walls.
- C. Plastic pipe fittings shall be solvent welded using solvents and methods as recommended by manufacturer of the pipe, except where screwed connections are required. Pipe and fittings shall be thoroughly cleaned of dirt, dust and moisture before applying solvent with a non-synthetic bristle brush. Care should be taken not to use an excess amount of solvent, thereby causing a burr or obstruction to form on the inside of the pipe. Allow the joints to set at least 24 hours before applying pressure on PVC pipe. Flush main and lateral piping on irrigation system to clean out all debris and sediment prior to the installation of heads and nozzles.
- D. Pressure test the mains minimum 2 hours at 150 PSI. Center-load all plastic pipe prior to pressure testing. The entire system shall be operating properly before any planting operations commence.
- E. Sprinkler heads shall be installed so that the top is slightly above finish grade. If finish grade has not been established, set the top of the sprinkler head 4" above grade and lower the sprinkler head when finish grade has been established and sod/mulch has been installed. Heads along

curbs and walks shall be set flush to within 1/8" and 6" away from curb or walk. Heads and piping adjacent to buildings shall be a minimum of 12" off face of building. No application of water shall be made within 12" of the exterior building walls. Sprinkler heads adjacent to bus loop shall be located 48" from back of curb or as shown/noted on irrigation plan. Adjust heads having an adjustment stem, for the proper radius and throw for the area involved. Do not allow over-spray on buildings, walkways or on motor vehicles.

- F. Irrigation heads shall be installed as designated on the Plans and per the Parks & Recreation Department's standard details. Upon coverage testing of the system if 100% coverage is not afforded by the system as designed, additional heads shall be added as necessary to achieve 100% coverage.
- G. All control wires shall be installed in a neat and orderly fashion underneath the main and lateral pipes, if possible. 10" loops shall be provided at each valve where control wires are connected.
- H. All piping and wiring passing under existing or future paving, construction, etc., shall be encased in sleeve(s) as specified, extending at least 12" beyond edges of paving base or construction.
- I. Install warning tape directly above pressure piping, 12 inches below finish grade except under paving or slabs or where depth shall be 6 inches.

7. BACKFILLING AND COMPACTING

- A. After pressure testing is complete and systems are approved, or sections thereof, backfill excavations and trenches with clean soil, free of rubbish. Dress off all areas to finish grades. Repeat backfilling as required due to settlement.
- B. Balance and adjust the irrigation system components for efficient, proper operation. This includes controller synchronization as well as individual controller stations, valves and sprinkler head adjustments. Do not allow over-spray on buildings, walkways or other paving or on automobiles.
- C. Backfill shall be uniformly tamped in 4-inch layers under and around the pipe for the full width of the trench and the full length of the pipe. Materials shall be sufficiently damp to permit thorough compaction, free of voids. Backfill shall be compacted to dry density equal to adjacent undisturbed soil and shall conform to adjacent grades.
- D. Flooding in lieu of tamping is not allowed without specific prior written approval of the Parks & Recreation Department.

8. RAIN SENSOR

- A. Install rain sensor on exposed surface that is unobstructed from rainfall. Install rain sensor control wiring in rigid conduit as detailed. Preferred location of the rain sensor is within 20 feet of the controller.

9. LABELS

- A. Number each zone valve box on inside of valve box with a Christy zone tag. Numbers shall match the zone numbers on the drawings.
- B. Number each zone valve control wire at the controller with a waterproof marker and tags. Numbers shall match the zone numbers on the drawings.

10. PRESSURE TESTING/SYSTEM DEMONSTRATION

- A. All piping, connectors and valves shall be hydrostatically pressure tested. The mainline test shall last for a minimum of six (6) hours at 100 PSI. All leak areas and equipment shall be replaced and the system shall be re-tested until no leaks are found. All testing shall be done before backfilling trenches.
- B. Provide a complete demonstration to the City of Santa Clara's Authorized Representative of the operation of all components of the irrigation system as part of Close Out procedures.
- C. Provide complete typewritten instructions for operation including recommended watering times, duration and preventative maintenance.

11. MAINTENANCE

- A. Maintain the irrigation system until the date of Final Completion.
- B. Maintenance shall include work, materials and replacements necessary to insure a complete properly operating system.

12. CITY'S RESPONSIBILITY FOR MAINTENANCE

- A. It is the City's responsibility to maintain the system in working order during the guarantee period, performing necessary minor maintenance, keeping grass from obstructing the sprinkler heads and preventing vandalism and damage during the landscape maintenance operation.

13. CLEAN-UP

- A. Upon completion and prior to inspection of the work, clear the site of debris, superfluous materials and equipment.

Chapter 3 – Plant Palette

Section 1 – GENERAL PLANT PALETTE

1. DEFINITION

- A. The purpose of this guideline is to establish minimum standards for the landscape design and planting of trees, shrubs and groundcovers.

2. APPLICATION

- A. This section includes the following:
 - 1) Trees
 - 2) Shrubs, Groundcovers and Vines
 - 3) Outdoor Classroom and Garden Planting
 - 4) Aquatic Plants

3. SELECTION CRITERIA

- A. Industry Standards
 - 1) American Standard for Nursery Stock
 - 2) Baileys Hortus Third
 - 3) ASTM Standards

4. SUBMITTALS

- A. Samples for Verification
 - 1) Each species of tree, shrub, vine and groundcover shall be tagged, submitted and approved before installation.
- B. Contractors Qualifications
 - 1) Contractor shall be licensed to do business in the State of California and shall possess a City of Santa Clara business license.
- C. Soils Testing
 - 1) Provide a complete soil test/analysis showing soil texture, drainage characteristics, water holding capacity, nutrient levels and organic matter content with indication of any and all potentially harmful soil characteristics that would inhibit or prevent plant growth.

5. QUALITY ASSURANCE

- A. Tree and Shrub Measurements.
 - 1) Measure according to Grades and Standards for Nursery Plants with branches and trunks in their normal position. Do not prune to obtain required sizes. Take measurements 6 inches above ground for trees up to 4-inch and 12-inches above ground for larger sizes.

6. DELIVERY STORAGE AND HANDLING

- A. Deliver exterior plants in nursery containers or properly prepared with root ball protected against damage.
- B. Root system shall be kept moist until planting.
- C. Do not prune trees and shrubs before delivery. Protect bark, branches and root system from sun scald, drying, sweating, whipping and tying damage. Do not bend or bind-tie trees or shrubs or destroy their natural shape.
- D. Deliver exterior plants after preparations for planting have been completed and install immediately. If planting is delayed more than 6 hours after delivery, set exterior plants in shade, protect from weather and mechanical damage and keep root system moist.
- E. Do not stage plants on hot pavement before planting.

7. WARRANTY

- A. Warrant the exterior plants for the warranty period indicated against defects including death and unsatisfactory growth.
 - 1) Warranty period for trees, shrubs, and groundcover: One year from date of substantial completion.
 - 2) Contractor shall be responsible for complete and proper planting supports installation layout, watering, fertilizing, and plant insecticides during warranty period.

Section 2 – PRODUCTS

1. TREE AND SHRUB MATERIAL

- A. Furnish nursery container grown trees and shrubs complying with Grades and Standards for Nursery Plants, with healthy root systems. All other trees shall be approved by Landscape Architect prior to planting. Provide well shaped, fully branched, healthy, vigorous stock free of disease, insects, eggs, larvae, and defects such as knots, sun scald, injuries, abrasions, and disfigurement.
- B. Provide trees and shrubs of sizes and grades complying with ANSI Z60.1 for type of trees and shrubs required.
- C. Label one exterior plant of each variety with a securely attached waterproof label with common name, scientific name, frequency of fertilization and frequency of watering.

2. TREES

- A. Provide single stem trees with straight trunk, well-balanced crown and intact leader, of height and caliper indicated, complying with Grades and Standards for Nursery Plants for type of trees required.
 - 1) Provide container grown trees.
 - 2) Branching height shall be as specified.
 - 3) Multi-stem trees shall be branched or pruned naturally to retain the natural form of the tree, with relationship of caliper, height, and branching according to Grades and Standards for Nursery Plants.

3. GROUNDCOVER AND VINES

- A. Provide groundcover of species indicated, established and well rooted in containers and complying with Grades and Standards for Nursery Plants.
- B. Provide vines of species indicated complying with Grades and Standards for Nursery Plants. Vines shall be two – year plants with heavy well branched tops, with not less than three runners 18 – inches or more in length with a well-developed root system.

4. TOPSOIL

- A. Topsoil shall be as described in ASTM D 5268, with pH range of 5.5 to 6.5, a minimum of 4 percent organic material content, free of stones and organic materials that are harmful to plant growth.
- B. Reuse surface soil stockpiled on site. Clean surface soil of roots, stones, clay lumps, construction spoils, and materials that are harmful to plant growth.
- C. Supplement with imported topsoil from offsite sources when quantities are insufficient. Obtain topsoil displaced from naturally well drained sites where topsoil occurs at least 4 inches deep. Do not obtain topsoil from bogs or marshes.

5. ORGANIC SOIL AMENDMENTS

- A. Compost: Well composted, stable, weed free organic matter, pH range of 5.5 to 6.5; moisture content 35 to 55 percent by weight, 100 percent passing through ½ inch sieve.

- B. Peat: Finely divided or granular texture, with a pH range of 5.5 to 6.5, containing partially decomposed peat, native peat, or reed sedge peat having a water absorbing capacity of 1100 to 2000 percent.

6. FERTILIZER

- A. Commercial grade complete fertilizer of neutral character consisting of slow release nitrogen, 50 percent derived from natural organic sources of urea formaldehyde, phosphorous and potassium. Fertilizer shall correspond to results of soils test and shall include minor elements.

7. MULCHES

- A. Mulch shall be native materials and 100 percent organic.

8. STAKES AND GUYS

- A. Upright stakes and guys, rough sawn, sound, new hardwood, redwood, free of knots, holes, cross grain, 2 inches by length shown.
- B. Pre-manufactured staking systems.
- C. Hose chafing guard, reinforced rubber or plastic hose at least ½ inch in diameter, black, cut to lengths required to protect tree trunks from damage.

9. MISCELLANEOUS PRODUCTS

- A. Anti-desiccant, water – insoluble emulsion, permeable moisture retarder, film forming for trees and shrubs.
- B. Deliver in original, sealed, and fully labeled containers and mix according to manufacturer's written instructions.

10. THE CITY OF SANTA CLARA PARKS DEPARTMENT STANDARDS PLANT PALETTE.

Common Name

Scientific Name

Trees

African sumac	Rhus lancea
Aleppo Pine	Pinus halepensis
American elm	Ulmus americana
American sweet gum	Liquidambar styraciflua
Aristocrat pear	Pyrus calleryana 'Aristocrat'
Ash	Fraxinus spp.
Australian Tea Tree	Leptospermum laevigatum
Australian willow	Geijera parviflora
Blackwood Acacia	Acacia melanoxylon
Bradford pear	Pyrus c. 'Bradford'
Brazilian pepper tree	Schinus terebinthifolius

Brisbane box	Lophostemon confertus
Bronze loquat	Eriobotrya deflexia
Cajeput tree	Melaleuca quinquenervia
California buckeye	Aesculus californica
California Pepper Tree	Schinus molle
California sycamore	Platanus racemosa
Camphor Tree	Cinnamomum camphora
Canary Island Pine	Pinus canariensis
Carob	Ceratonia siliqua
Carrot wood	Cupaniopsis anacardioides
Chinese elm	Ulmus parvifolia
Chinese Hackberry	Celtis sinensis
Chinese Pistache	Pistacia chinensis
Chinese tallow	Sapium sebiferum
Coast live oak	Quercus agrifolia
Coast Redwood	Sequoia sempervirens
Compact Blue Gum	Eucalyptus globulus 'Compacta'
Cork oak	Quercus suber
Crape Myrtle	Lagerstroemia fauriei 'Tuscorora'
Crape Myrtle	Lagerstroemia indica (various)
Deodar Cedar	Cedrus deodara
Drooping She-Oak	Casuarina stricta
Eastern dogwood	Cornus florida
Eastern redbud	Cercis Canadensis
English hawthorn	Crataegus laevigata
Eucalyptus	Eucalupyus spp.
European fan palm	Chamaerops humilis
European Hackberry	Celtis australis
European White Birch	Betula pendula
Evergreen Ash	Fraxinus uhdei
Evergreen elm	Ulmus parvifora
Evergreen Pear	Pyrus kawakamii
Fern pine	Podocarpus gracilitor
Flooded Gum	Eucalyptus rudis
Flowering cherry, plum	Prunus spp.
Flowering dogwood	Cornus florida
Flowering locust	Robinia spp.
Fruitless mulberry	Morus alba 'Fruitless'
Glossy privet	Ligustrum lucidum
Gray pine	Pinus sabiniana
Grecian laurel	Laurus nobilis
Holly oak	Quercus ilex

Hollyleaf Cherry	Prunus ilicifolia
Honey locust	Gleditsia spp.
Italian Alder	Alnus cordata
Italian Cypress	Cupressus sempervirens
Italian stone pine	Pinus pinea
Jacaranda	Jacaranda mimosifolia
Japanese black pine	Pinus thunbergii
Japanese Maple	Acer palmatum
Japanese pagoda tree	Sophora japonica
Laurel leaf box	Tristaniopsis laurina
Lemon bottlebrush	Callistemon citrinus
Little leaf fig	Ficus microcarpa 'Nitida'
Little leaf linden	Tilia cordata
Lombardy Poplar	Populus nigra 'Italica'
London Plane Tree	Platanus acerfolia 'Bloodgood'
Loquat	Eriobotrya japonica
Maples	Acer spp.
Magnolia	Magnolia grandiflora
Maidenhair tree	Ginkgo biloba
Mayten	Maytenus boaria
Modesto Ash	Fraxinus velutina 'Modesto'
Swiss mountain pine	Pinus mugo
Monterey Pine	Pinus radiata
Myoporum	Myoporum laetum
New Zealand Christmas	Metrosideros excelsus
Oak	Quercus spp. - Native to Santa Clara Valley
Oleander	Nerium oleander
Olive	Olea europea 'Manzanillo'
Olive (Fruitless)	Olea europea "Bonita"
Ornamental Pear	Pyrus calleryana 'Aristocrat'
Paper Bark Maple	Acer griseum
Paper birch	Betula Papyrifera
Pepper tree	Schinus molle
Peppermint tree	Agonis Flexuosa
Phoenix palm	Palm spp.
Pittosporum	Pittosporum eugenioides
Ponderosa pine	Pinus ponderosa
Purple Leaf Plum	Prunus cerasifera 'Krauter Vesuvius'
Queensland pittosporum	Pittosporum rhombifolium
Kousa dogwood	Cornus kousa
Raywood Ash	Fraxinus angustifolia 'Raywood'
Red Gum	Eucalyptus camaldulensis

Red Ironbark
Red mapple
Red oak
River Birch
Sawtooth zelkova
Scotch pine
Scarlet oak
Shademaster Honeylocust
Sidney golden wattle
Silk Tree
Southern magnolia
Strawberry Tree
Valley oak
Victorian box
Weeping bottlebrush
Weeping Willow
Western dogwood
Western catalpa
White Alder
White Ironbark
White Mulberry
Yew pine
Yoshino Flowering Cherry

Eucalyptus sideroxylon
Acer rubrum
Quercus rubra
Betula nigra
Zelkova serrata
Pinus sylvestris
Quercus coccinea
Gleditsia tricanthos inermis
Acacia longifolia
Albizia julibrissin
Magnolia grandiflora
Arbutus unedo
Quercus lobata
Pittosporum undulatum
Callistemon viminalis
Salix babylonica
Cornus nuttallii
Catalpa speciosa
Alnus rhombifolia
Eucalyptus leucoxyton 'Rosea'
Morus alba
Podocarpus macrophyllus
Prunus yedoensis 'Akebono'

Groundcovers

Aaron's Beard/Creeping St Johnswart
Rock Cotoneaster
Algerian Ivy
Coprosma
Lantana
Myoporum
Star Jasmine
Trailing African Daisy

Hypericum calycinum
Contoneaster horizontalis
Hedera canariensis
Coprosma kirkii
Lantana montevidensis 'Carnaval'
Myoporum parvifolium 'Putah Creek'
Trachelospermum jasminoides
Osteospermum fruticosum

Vines

Cat's Claw
Chinese Wisteria
Evergreen Clematis
Jasmine

Macfadyena unguis-cati
Wisteria sinensis
Clematis armandii
Jasminum

Perennials

Dwarf Lily of the Nile

Agapanthus africana 'Peter Pan'

Fortnight Lily
Lily of the Nile
Lily of the Nile
Society Garlic
Trailing Lantana
Yellow Sage

Dietes and cultivars
Agapanthus 'Queen Ann'
Agapanthus africana
Tulbaghia violacea
Lantana montevidensis
Lantana camara

Shrubs

Camellia
Dwarf Myrtle
Escallonia
Firethorn
Glossy Abelia
Gold Flower
Grevillia
Heavenly Bamboo
Hollyleaf Cherry
Hollywood Juniper
Hoopseed Bush
India Hawthorn
Laurustinus
Lavender
New Zealand Flax
Oleander
Oregon Grape
Photinia
Pride of Madeira
Prostrate Rosemary
Rockrose
Salvia
Sandankwa Viburnum
Shiny Xylosma
Sweet-scented Hakea
Tobira
Toyon
Wax-Leaf Privet
Wild Lilac
Wooly Grevillia

Camellia japonica cultivars
Myrtus communis 'Compacta'
Escallonia exoniensis 'Frades'
Pyracantha 'Santa Cruz'
Abelia grandiflora
Hypericum moserianum
Grevillea 'Noelii'
Nandina domestica
Prunus ilicifolia
Juniperus chinensis 'Torulosa'
Dodonaea viscosa
Raphiolepis indica & cultivars
Viburnum tinus 'Spring Boquet'
Lavandula species
Phormium tenax
Nerium oleander & cultivars
Mahonia aquifolium
Photinia fraseri
Echium fastuosum
Rosmarinus officinalis 'Collingwood Ingram'
Cistus 'Doris Hibberson'
Salvia spp.
Viburnum suspensum
Xylosma congestum
Hakea suaveolens
Pittosporum tobira and cultivars
Heteromeles arbutifolia
Ligustrum japonicum 'Texanum'
Ceanothus griseum horizontalis
Grevillea lanigera

Wetland Plants

Alkali bulrush
Arroyo willow

Bolboschoenus
Salix lasiolepis

California bulrush
Red willow

Schoenoplectus californicus
Salix laevigata

Native Grasses

Blue Wildrye
California Brome
California fescue
California Tufted Hairgrass
Coast Range Melic
Creeping Wildrye
Deer Grass
Hard Fescue
Idaho Fescue
Meadow Barley
Molate Blue Fescue
Molate Fescue
Nodding Needle Grass
Pacific Reed Grass
Purple Needle Grass
Western Fescue

Elymus glaucus
Bromus carinatus
Salvia clevelandii
Deschampsia caespitosa
Milica imperfecta
Elymus triticoides
Muhlenbergia rigns
Festuca longifolia
Festuca idahoensis
Hordeum brachyantherus
Festuca rubra 'Molate Blue'
Festuca rubra
Stipa cernua
Calamagrotis nutkaensis
Stipa pulchra
Festuca californica

11. INVASIVE, NON-NATIVE PLANTS PROHIBITED

- A. No plant listed on the UC IPM Invasive Plants List may be used.

PART 3 - EXECUTION

1. EXAMINATION

- A. Landscape Architect shall approve all plant material for compliance with product requirements and shall review site conditions affecting installation and performance. Proceed with installation after unsatisfactory conditions have been corrected.

2. PREPARATION

- A. Protect structures and the work of other trades from damage caused from planting operations.
- B. Provide erosion control measures to prevent erosion or displacement of soils and discharge of soil bearing water runoff or airborne dust to adjacent properties and walkways.
- C. Layout individual tree and shrub locations by staking. Obtain Landscape Architect's acceptance of layout before planting.

3. TREE AND SHRUB PLANTING

- A. Set balled, potted or boxed stock plumb and in the center of pit with top of root ball slightly above the adjacent finish grade.
- B. Remove burlap and wire baskets from upper one third of root balls and sides. Do not remove burlap from under root ball. No non-biodegradable material shall be left on the root ball.
- C. Place soil around root ball in layers, tamping to settle mix and eliminate voids. When pit is one – half backfilled, water thoroughly before placing remainder of backfill. Repeat watering until no more water is absorbed. Water again after placing and tamping final layer of soil.
- D. Apply mulch at specified thickness around exterior plantings. Extend mulch 12 inches beyond edge of planting pit and as shown on the drawings. Do not place mulch within 3 inches of trunks or stems.
- E. Place fertilizer tablets per manufacturer's recommendation. Apply granular fertilizer after planting and before mulching.

4. GUYING AND STAYING

- A. Stake and guy trees across the root ball.

5. TREE AND SHRUB PRUNING

- A. Prune trees to remove dead and damaged branches and to provide specified clear trunk. Do not cut tree leaders. Prune shrubs to retain natural character. Pruning shall be done with the direction and supervision of the Landscape Architect.
- B. Add a saucer around trees to hold water per landscape drawings.

6. PLANTERS

- A. Planter soil mix shall be as follows: equal parts top soil and coarse sand, 4%, and 10% perlite.

7. GROUNDCOVER PLANTING

- A. Refer to the drawings for the spacing and locations for groundcover and plants.
- B. Dig holes large enough to allow spreading of roots and backfill with planting soil.
- C. Work soil around roots to eliminate voids. Add a saucer indentation around entire groundcover bed to hold water.
- D. Water thoroughly after planting.

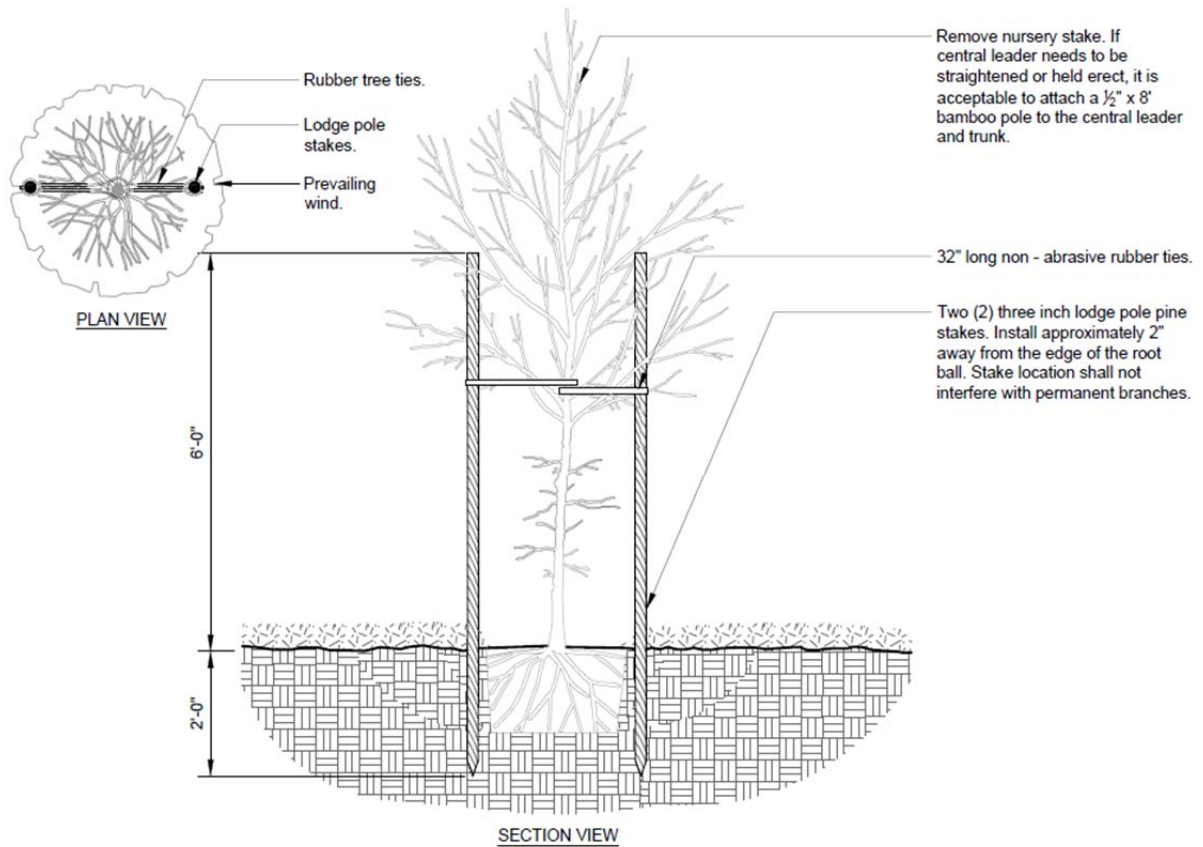

P-X TREE STAKING - LODGE POLES (2)

URBAN TREE FOUNDATION © 2014
OPEN SOURCE FREE TO USE

PLANTING DETAIL P-1

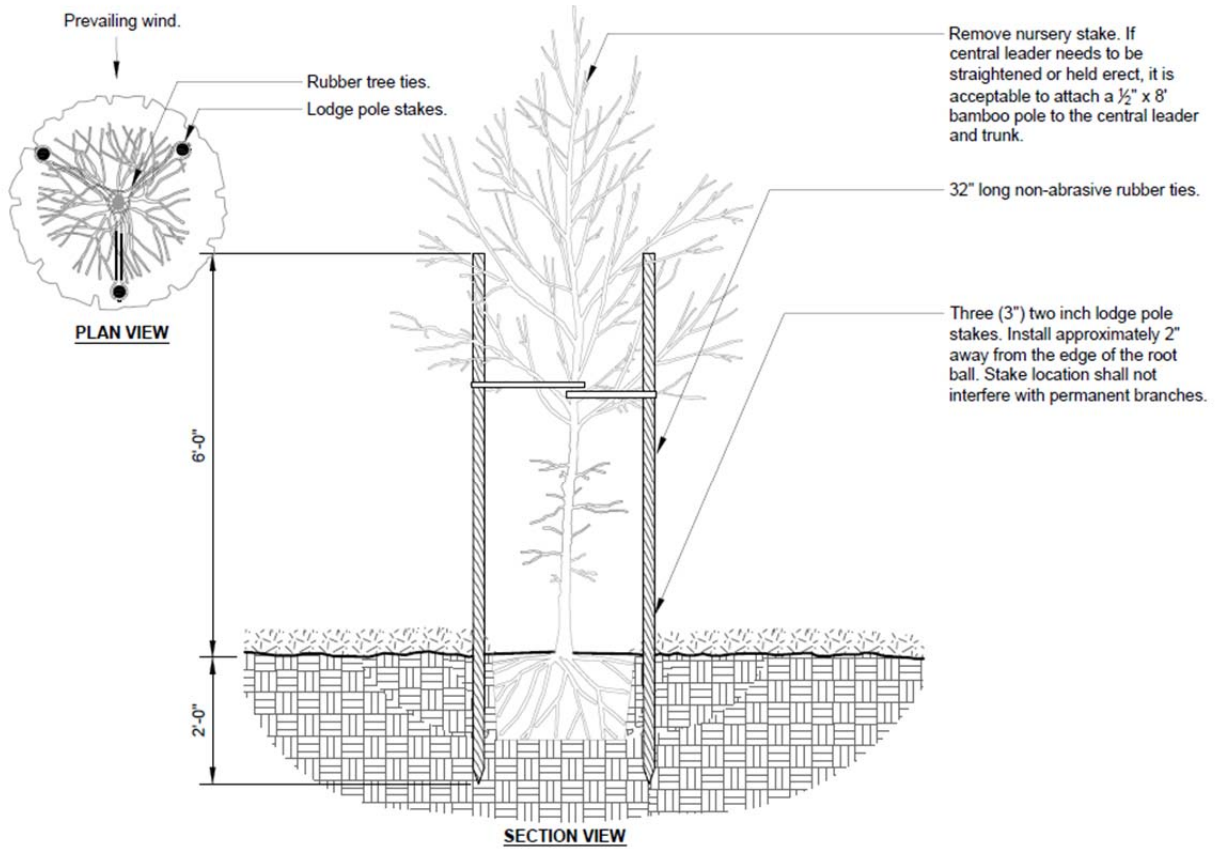

P-X

TREE STAKING - LODGE POLES (3)

URBAN TREE FOUNDATION © 2014
OPEN SOURCE FREE TO USE

PLANTING DETAIL P-2

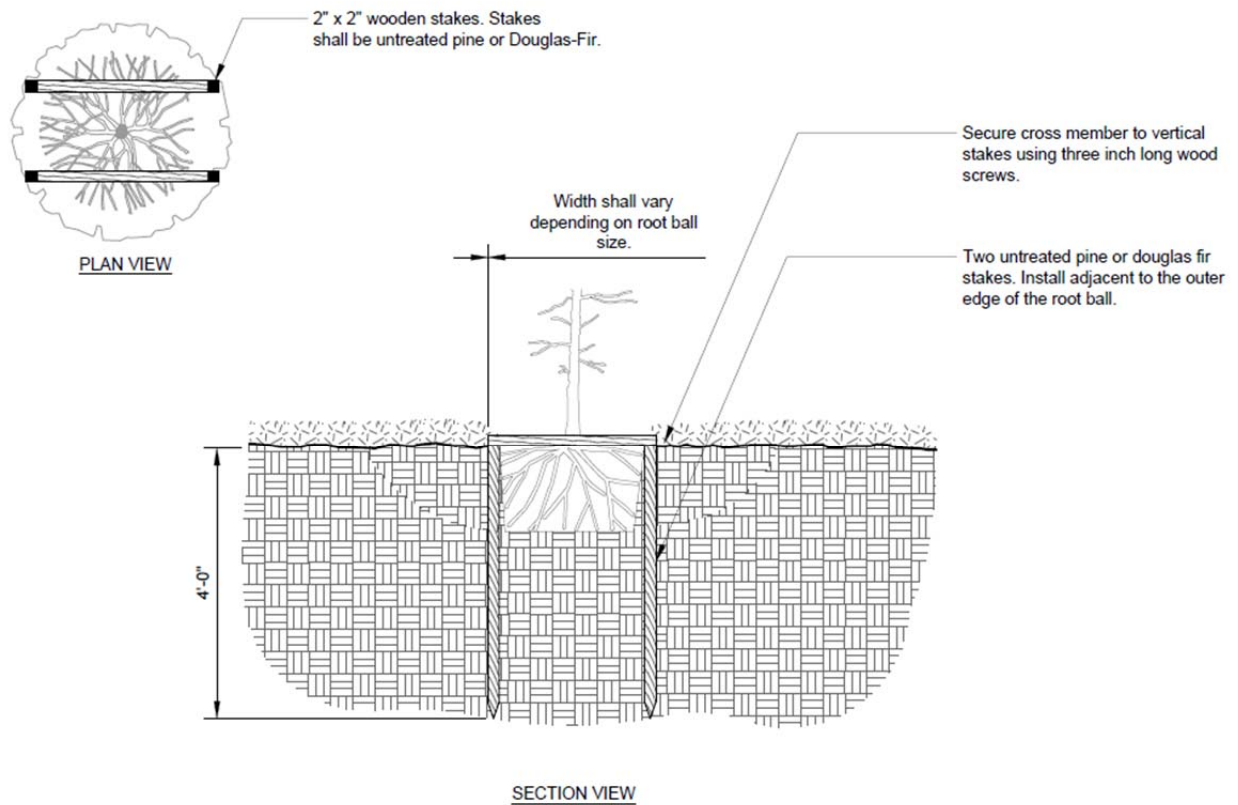

P-X TREE STAKING - STAPLE

URBAN TREE FOUNDATION © 2014
OPEN SOURCE FREE TO USE

PLANTING DETAIL P-3

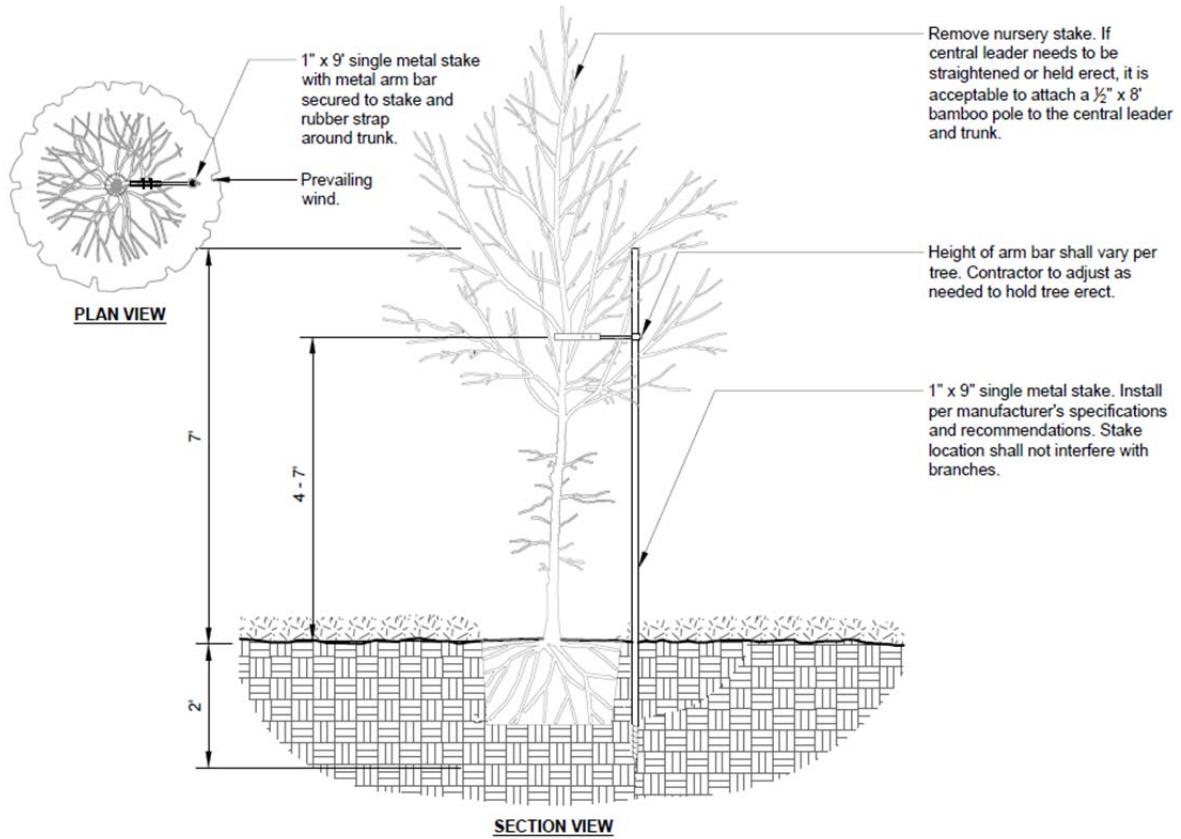

P-X TREE STAKING - SINGLE METAL STAKE

URBAN TREE FOUNDATION © 2014
OPEN SOURCE FREE TO USE

PLANTING DETAIL P-4

Notes:

1- Trees shall be of quality prescribed in crown observations and root observations details and specifications.

2- See specifications for further requirements related to this detail.

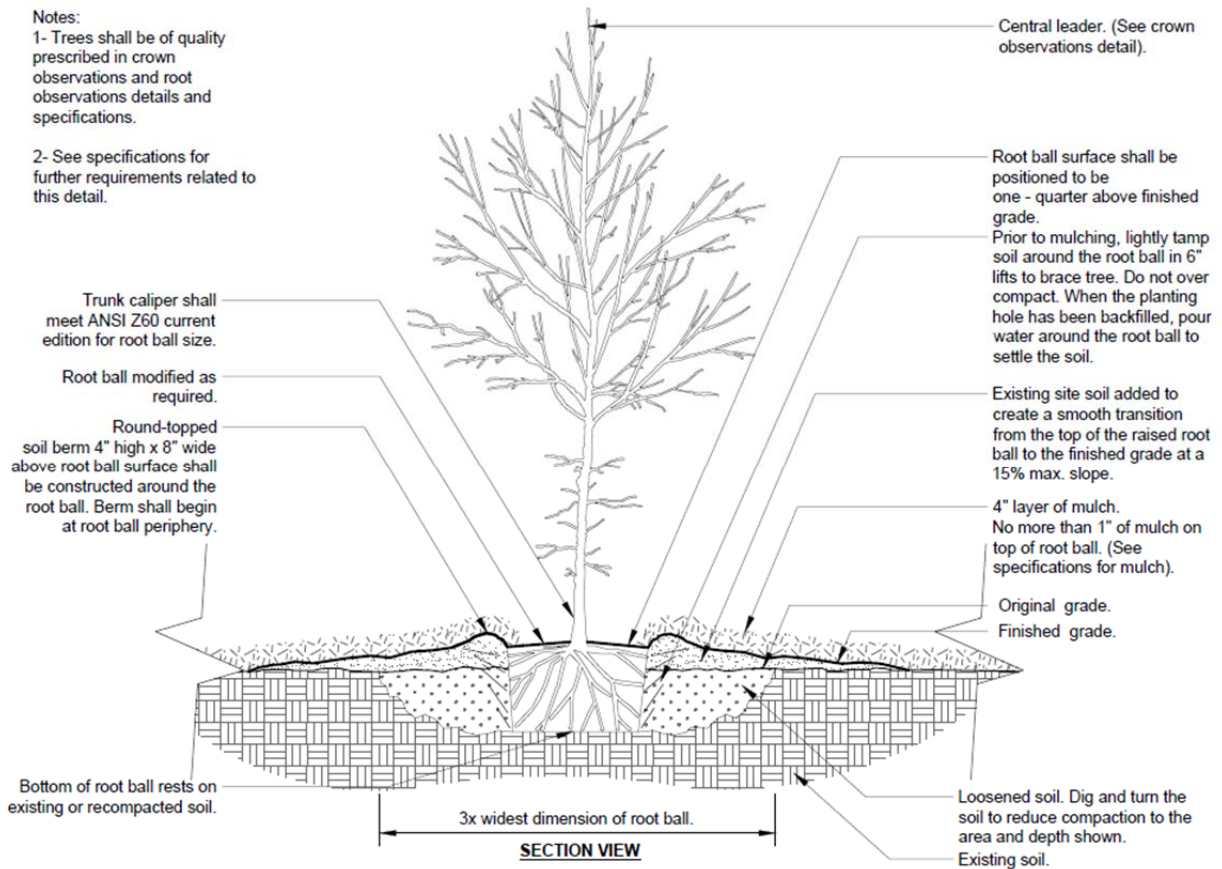

P-X

TREE IN POORLY DRAINED SOIL

URBAN TREE FOUNDATION © 2014
OPEN SOURCE FREE TO USE

PLANTING DETAIL P-5

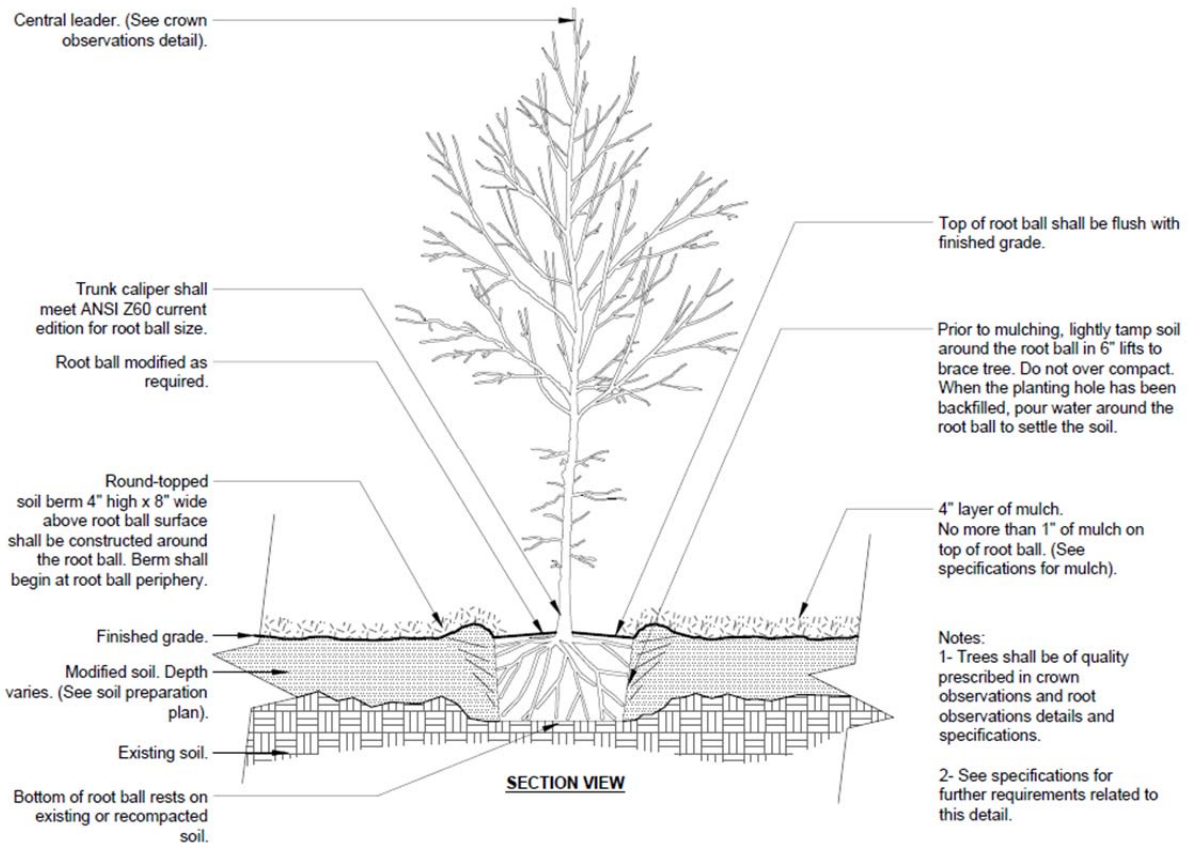

P-X TREE w/ BERM (EXISTING SOIL MODIFIED)

URBAN TREE FOUNDATION © 2014
 OPEN SOURCE FREE TO USE

PLANTING DETAIL P-6

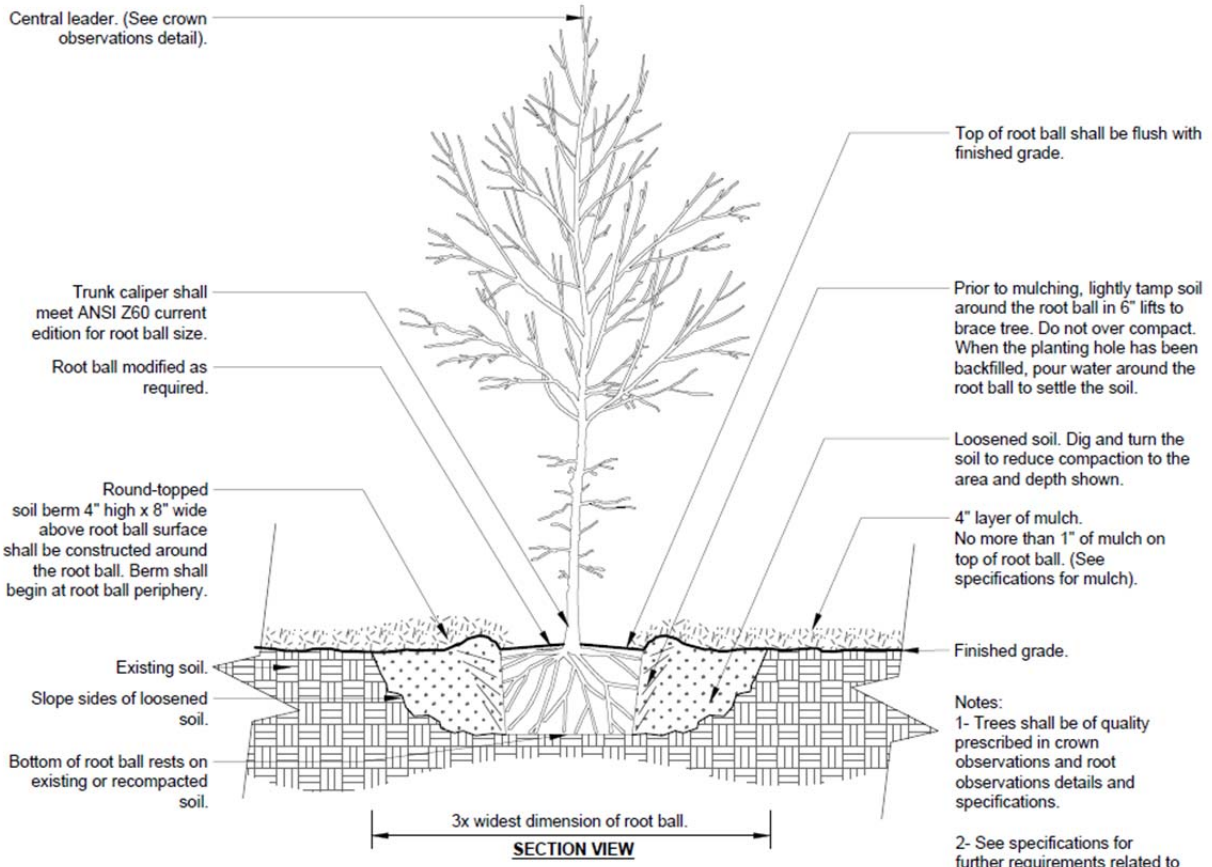

- Notes:
- 1- Trees shall be of quality prescribed in crown observations and root observations details and specifications.
 - 2- See specifications for further requirements related to this detail.

URBAN TREE FOUNDATION © 2014
OPEN SOURCE FREE TO USE

P-X

TREE w/ BERM (EXISTING SOIL NOT MODIFIED)

PLANTING DETAIL P-7

Notes:

1- Trees shall be of quality prescribed in crown observations and root observations details and specifications.

2- See specifications for further requirements related to this detail.

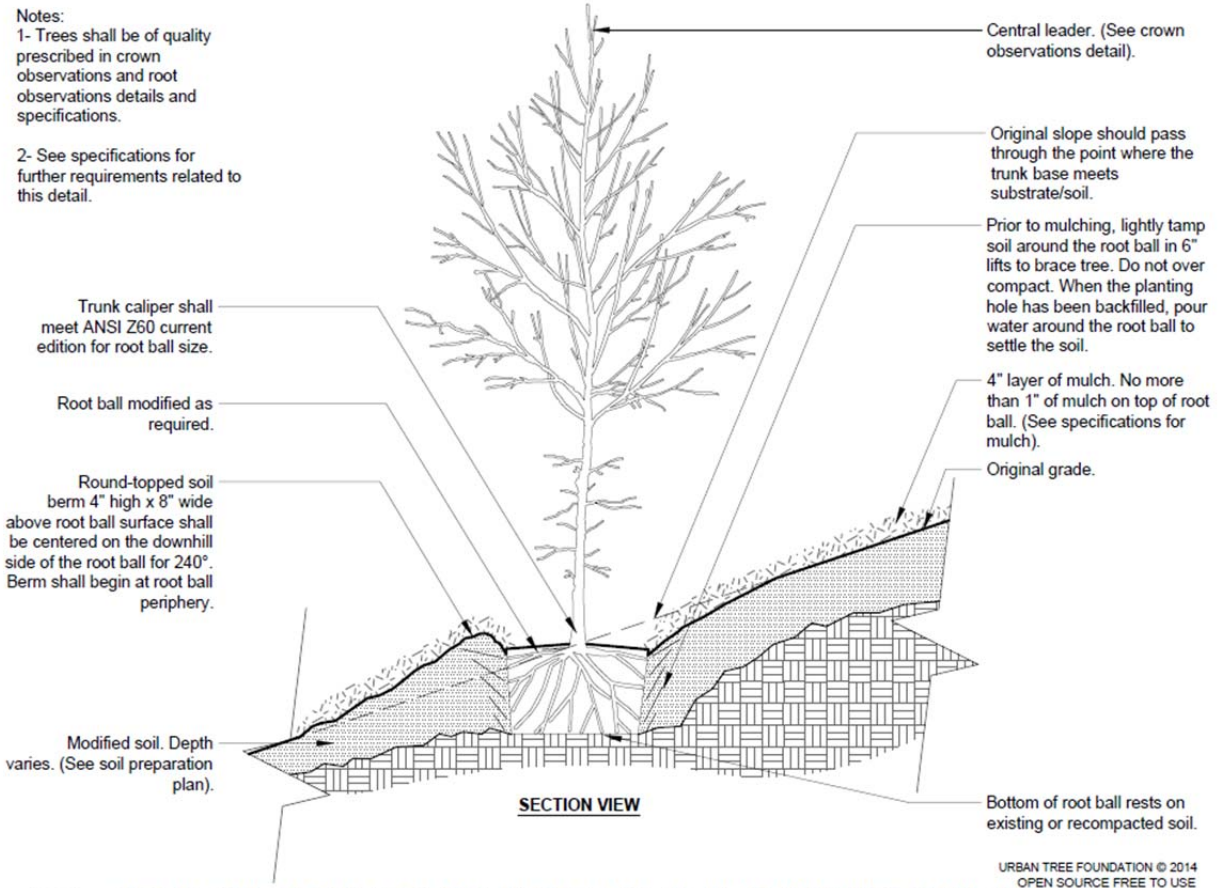

P-X TREE ON SLOPE 5% (20:1) TO 50% (2:1) (EXISTING SOIL MODIFIED)

PLANTING DETAIL P-8

Notes:

1- Trees shall be of quality prescribed in crown observations and root observations details and specifications.

2- See specifications for further requirements related to this detail.

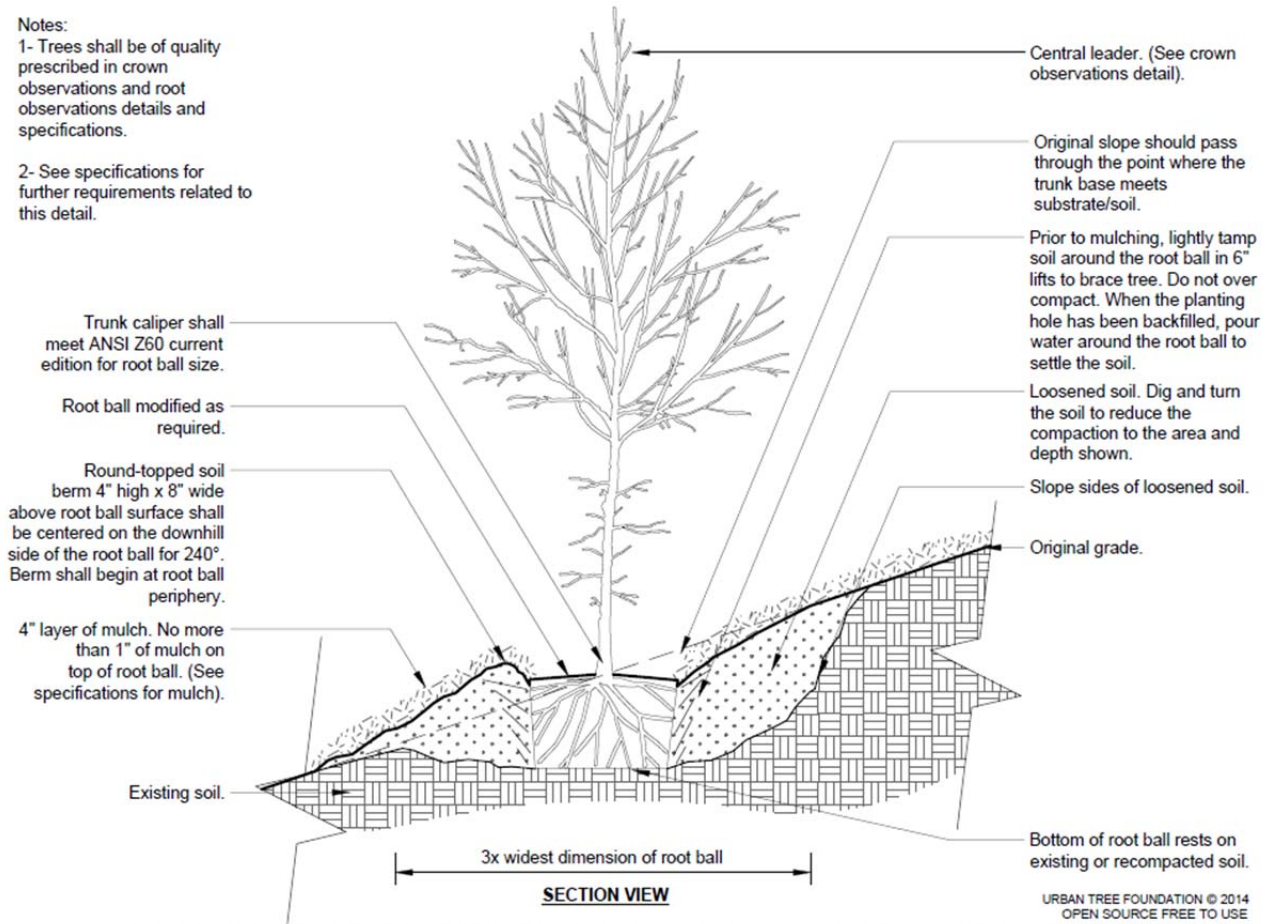

P-X

TREE ON SLOPE 5% (20:1) TO 50% (2:1) - UNMODIFIED SOIL

PLANTING DETAIL P-9

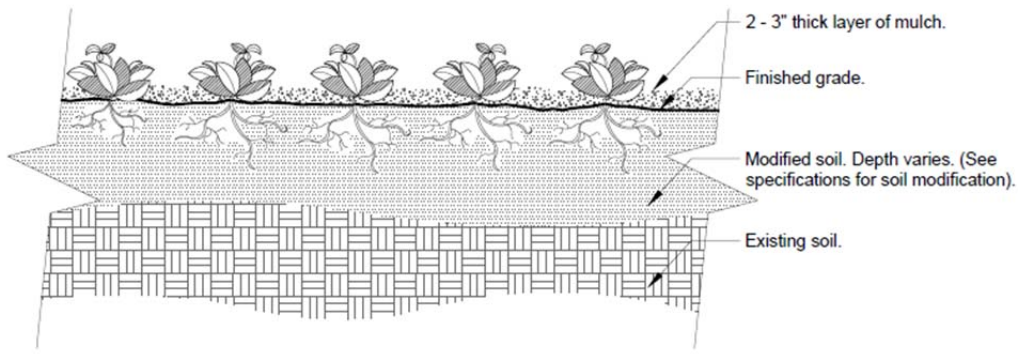

SECTION VIEW

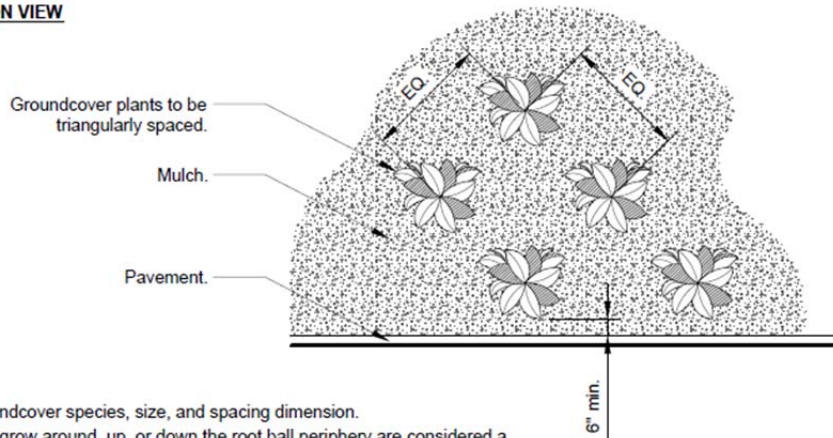

PLAN

Notes:

- 1- See planting legend for groundcover species, size, and spacing dimension.
- 2- Small roots ($\frac{1}{4}$ " or less) that grow around, up, or down the root ball periphery are considered a normal condition in container production and are acceptable however they should be eliminated at the time of planting. Roots on the periphery can be removed at the time of planting. (See root ball shaving container detail).
- 3- Settle soil around root ball of each groundcover prior to mulching.



GROUNDCOVER

URBAN TREE FOUNDATION © 2014
OPEN SOURCE FREE TO USE

PLANTING DETAIL P-10

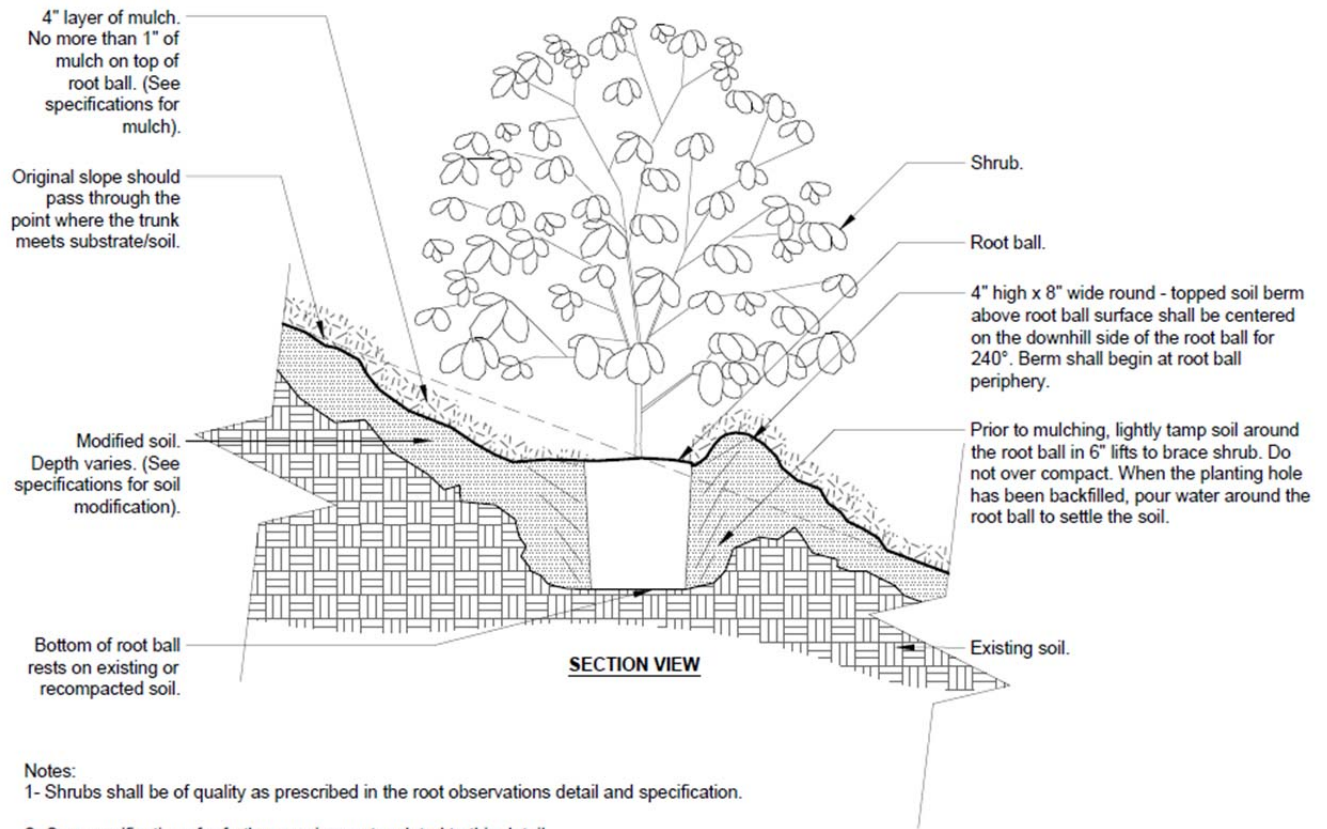

URBAN TREE FOUNDATION © 2014
OPEN SOURCE FREE TO USE

P-X

SHRUB ON SLOPE 5% (20:1) TO 50% (2:1) - MODIFIED SOIL

PLANTING DETAIL P-11

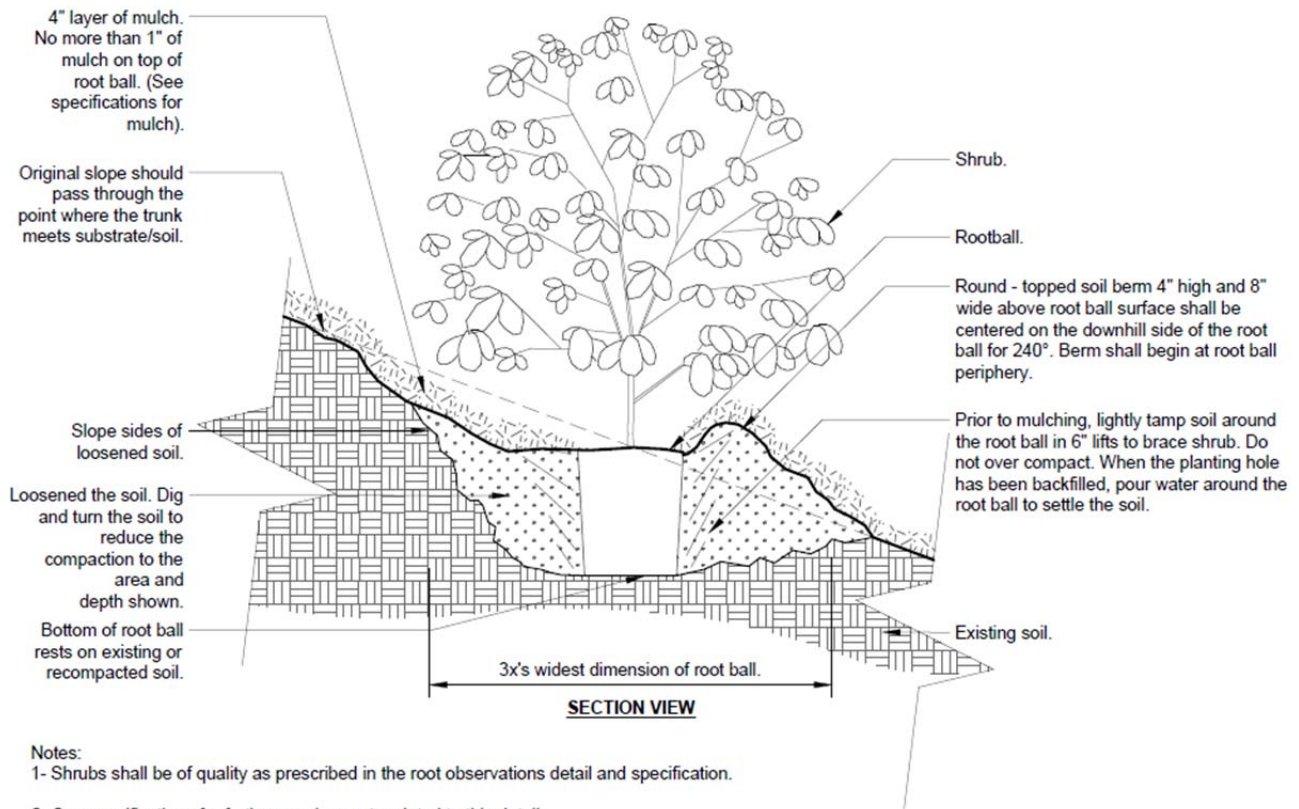

URBAN TREE FOUNDATION © 2014
 OPEN SOURCE FREE TO USE

P-X

SHRUB ON SLOPE 5% (20:1) TO 50% (2:1) - UNMODIFIED SOIL

PLANTING DETAIL P-12

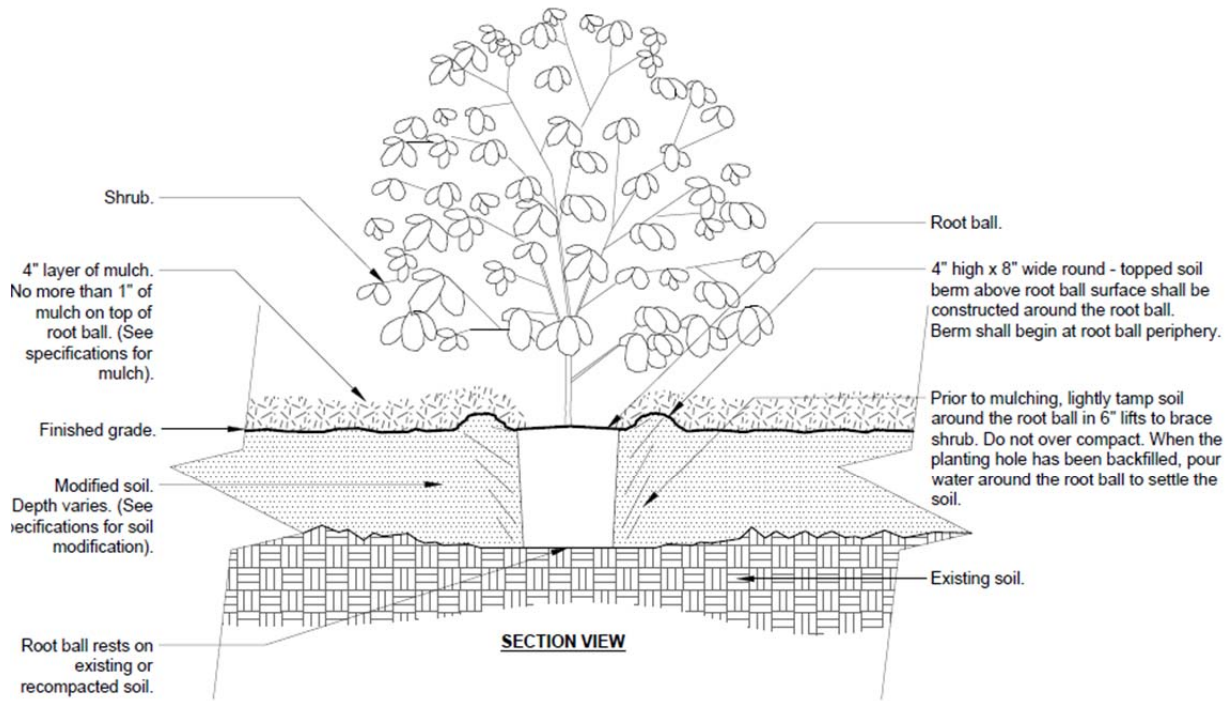

- Notes:
- 1- Shrubs shall be of quality prescribed in the root observations detail and specifications.
 - 2- See specifications for further requirements related to this detail.

P-X SHRUB - MODIFIED SOIL

URBAN TREE FOUNDATION © 2014
OPEN SOURCE FREE TO USE

PLANTING DETAIL P-13

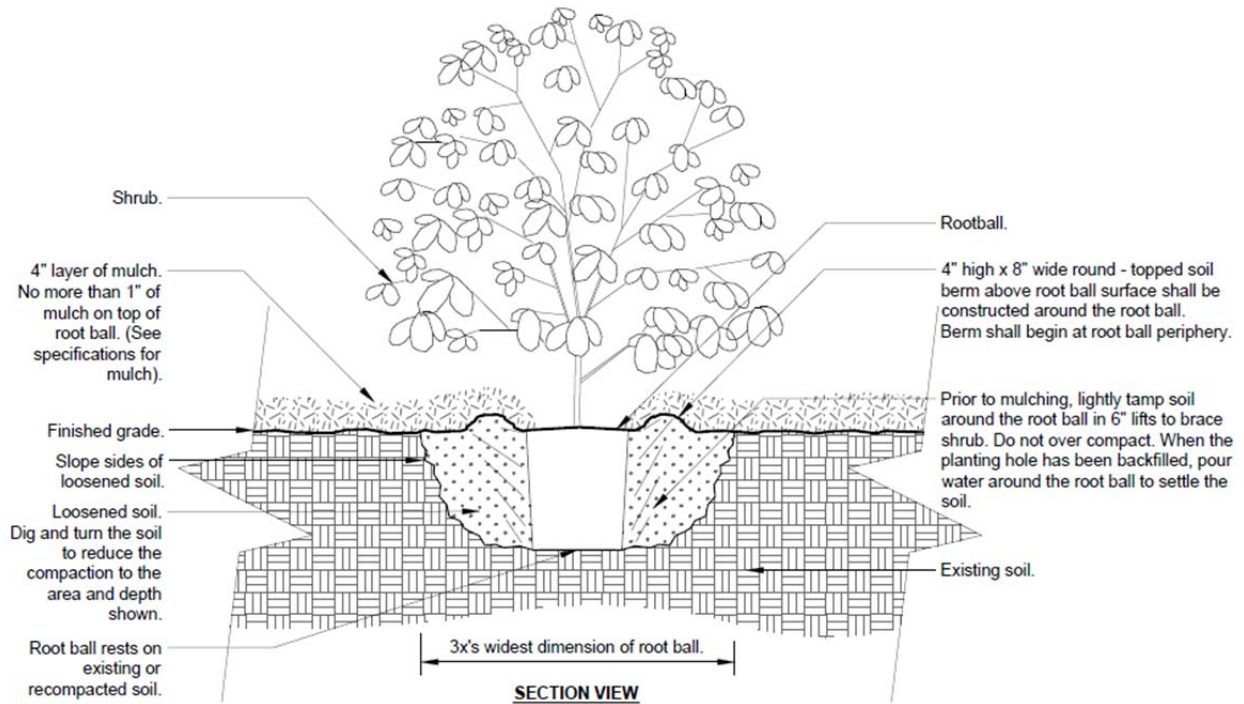

Notes:

- 1- Shrubs shall be of quality prescribed in the root observations detail and specifications.
- 2- See specifications for further requirements related to this detail.



SHRUB - UNMODIFIED SOIL

URBAN TREE FOUNDATION © 2014
OPEN SOURCE FREE TO USE

PLANTING DETAIL P-14

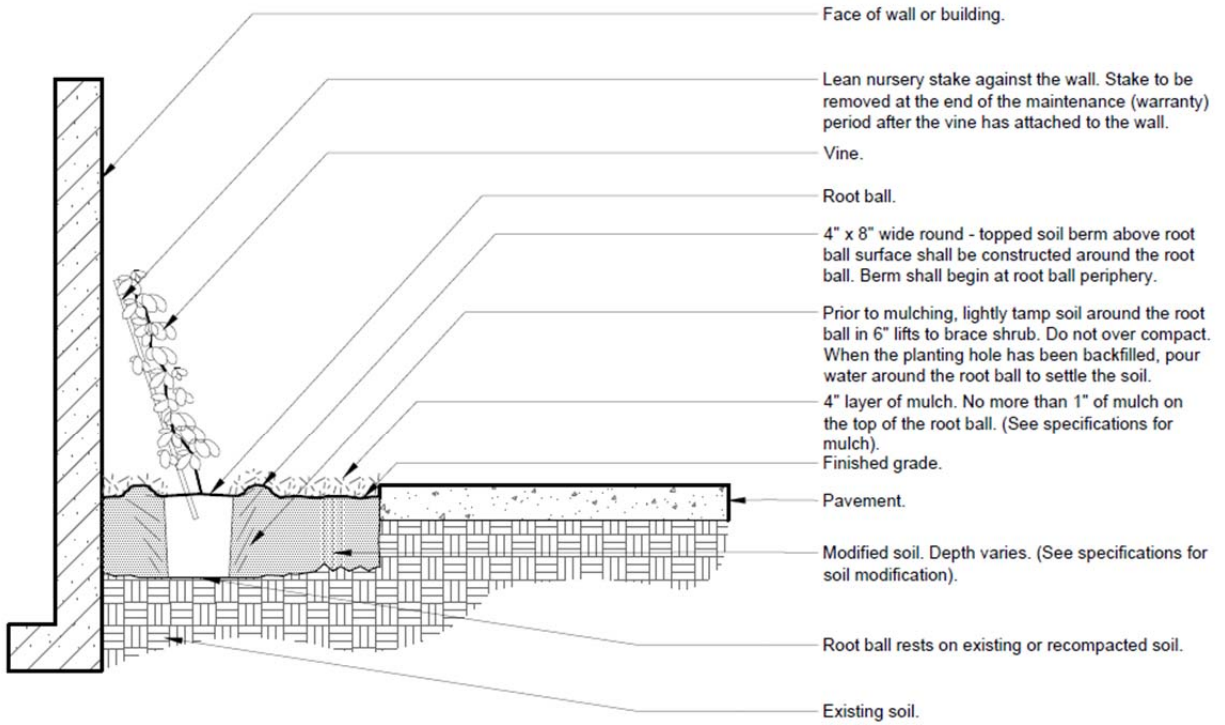

- Notes:
- 1- Vines shall be of quality as prescribed in the root observations detail and specifications.
 - 2- See specifications for further requirements related to this detail.



VINE - MODIFIED SOIL

URBAN TREE FOUNDATION © 2014
OPEN SOURCE FREE TO USE

PLANTING DETAIL P-15

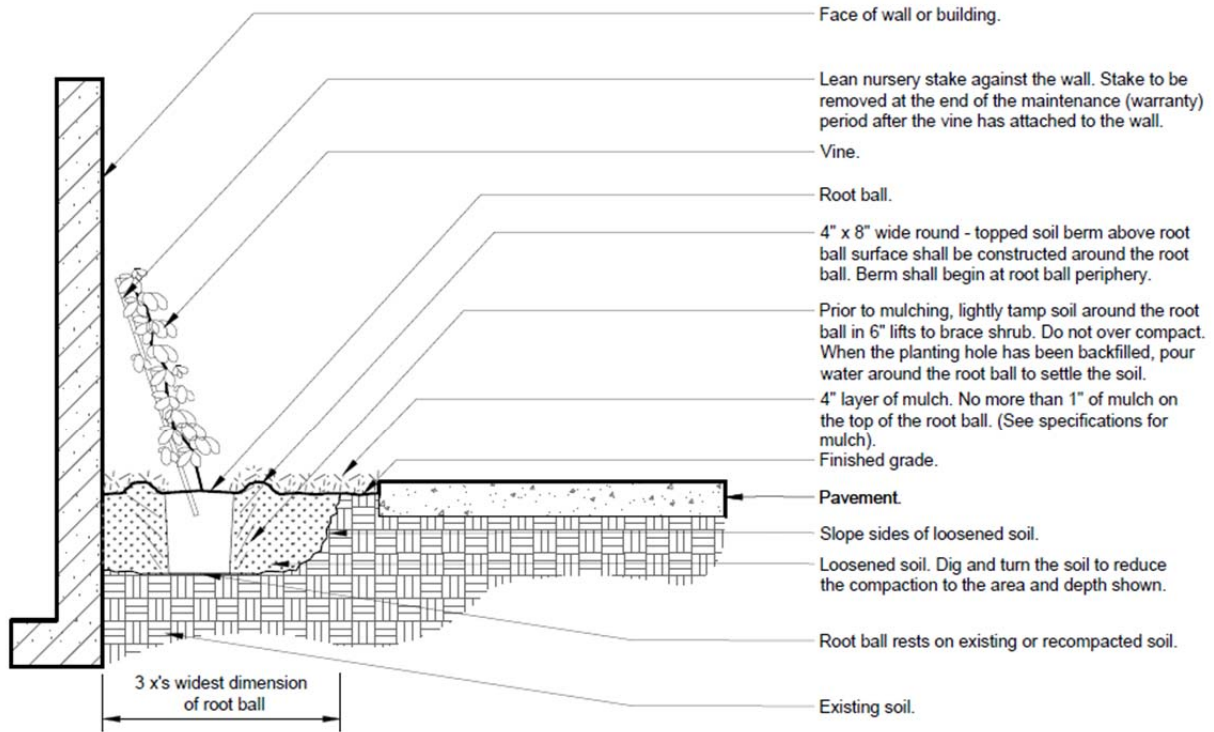

Notes:

- 1- Vines shall be of quality as prescribed in the root observations detail and specifications.
- 2- See specifications for further requirements related to this detail.



VINE - UNMODIFIED SOIL

URBAN TREE FOUNDATION © 2014
OPEN SOURCE FREE TO USE

PLANTING DETAIL P-16

Chapter 4—Ball Fields

Section 1 – Baseball Fields

1. DEFINITION
 - A. The work covered under this section includes designing and constructing a regulation size baseball field.
 - B. This section will cover the field, the dugouts and the spectator area.

2. DIMENSIONS
 - A. Base length: 90 feet
 - B. Mound size: 18 feet diameter; 10 inch height; to be constructed by the City after facility acceptance
 - C. Infield radius: 95 feet from center of mound
 - D. Pitching rubber: 60 feet 6 inches from back point of home plate to front of pitching rubber
 - E. Home plate to foul line: minimum: 320 feet; Idea: 320-340 feet
 - F. Home plate to centerfield: minimum: 380 feet; Ideal: 380 - 400 feet
 - G. Backstop to home plate: 30 feet
 - H. Minimum setback: 125 feet from home plate; 100 feet from base to street, parking areas or other park amenities and/or structures
 - I. Distance around field: 25 feet minimum flat area wide and clear of any obstructions provided around the outfield limit, except if there is a permanent outfield fence

3. INFIELD SURFACE
 - A. Turf
 - 1) Shall be established by sod.
 - 2) The grass type will be determined by the soil type and specific programmed use of the field.
 - 3) Upon installation, all netting at the back of the sod shall be removed.
 - B. In field mix shall be candlestick mix or approved equivalent.
 - C. Calcined clay may be added to mix per manufacturer's specifications.
 - D. The infield mix shall be six inches deep.
 - E. The finished grade shall be laser graded by a laser grader.

4. INFIELD EQUIPMENT
 - A. Home plates, bases, base ground anchors, and pitching rubbers shall be provided at the time of construction, but shall be installed by the city.
 - B. For ball diamonds with turf infields, a pitcher's mound cover and a home plate cover shall be provided.

5. INFIELD WATERING

- A. All infields shall have a manual irrigation watering system that is capable of watering all infield brick dust areas.
- B. Sufficient number of valves shall be provided depending on the available pressure and the size of the main line at the site.
- C. Sprinklers shall be installed along the perimeter of the infield area, 3/4 inch to 1 inch above the brick dust surface.
- D. The sprinkler heads shall be Rain Bird 6504 high speed stainless steel.
- E. Valves and valve boxes shall be installed at the end of the dugout fence, on the spectator side of the fence out of the path of travel and not blocking any views, Valves shall be Rain Bird GB series valves with the solenoid not wired, Valves shall be installed in rectangular valve boxes at least 14 inches by 20 inches, manufactured by Ametek, Carson, or an approved equal, and installed.
- F. Reclaimed water shall be used for all infield watering.

6. FIELD DRAINAGE

- A. A sub-grade infield drainage system that meets current regulations shall be installed for all regulation fields.

7. BACKSTOP

- A. Permanent backstop required.
- B. The back of backstop shall be centered behind the home plate and shall be 30 feet from home plate.
- C. Backstops and wings shall be 30 feet in height with a 10 foot cantilever (35 feet total height) behind home plate and extend 60 feet parallel to the first and third base-paths.
- D. Wings shall extend an additional 30 feet at a fence height of 30 feet high without a cantilever.
- E. The wings shall extend an additional 30 feet at a fence height of 20 feet without a cantilever.
- F. Backstop and wing fences shall be constructed with 6 gauge chain link.

8. CONCRETE PADS

- A. The area behind the backstop and wings, from first base to third base, shall be poured concrete; the minimum width of the concrete pad shall be 24 feet, including the bleachers and the access area.

9. BULLPENS

- A. As space permits on lighted fields, 75 feet by 10 feet fenced area with access from the dugouts shall be provided. The fence shall be 8 feet high on all sides. Bullpen shall be located outside the field of play. Alternative bullpen designs may be considered by staff on 80' and 90' fields.

10. WARM UP AREA

- A. As space permits on lighted fields, a flat and unobstructed space shall be provided near the field for two teams to warm up. This area should not be provided if there is an impact on other park activities or facilities.

11. SCOREBOARDS

- A. This is an optional item for ball diamonds.
- B. However, all ball diamonds shall have conduit and wiring installed from the electrical panel to one outfield light pole. Light pole shall be designed with brackets to support future installation of scoreboard.

12. LIGHTING

- A. The goal is that all fields at community parks are lighted for night-time use; however, each community park site shall be evaluated for appropriateness for lighting, Lighting will be included at neighborhood park sites with athletic fields whenever possible and appropriate, when lights are provided, access for boom trucks must be provided to facilitate lamp maintenance.
- B. Lighting levels shall be per standards specified for each type of field in the sections that follow.
- C. Minimum maintained lighting levels shall be 50 foot-candles over the infield and 30 foot-candles over the outfield.

13. DUGOUTS

- A. Dugouts shall be located along the first and third baselines, behind the backstop fence.
- B. They shall consist of concrete pads at field grade that are sloped away from the field, and surrounded by an 8 foot high 6 gauge chain link with black windscreen fabric on three sides and the top of the dugout.
- C. The windscreen fabric on top of the dugout shall be attached at a 9-foot height to the backstop wing, and at the top of the 8-foot high dugout fence, forming a "roof."
- D. The windscreen fabric on back and sides of dugout shall be attached from 18" from ground to 8' in height.
- E. The dugouts shall be 30 feet long, 10 feet wide, and equipped with a 25 foot long aluminum bench, a bat rack (on the home plate side of the dugout), latching gates to the infield swinging into the dugout and gates at each end of the dugout which swing into the dugout.

14. SEATING

- A. Spectator seating, when provided, shall consist of tiered concrete structures or portable bleachers containing five (5) rows of seating placed in an area approximately 28 feet by 14 feet. And must be ADA accessible.
- B. Bleachers are required on each side of the spectator area.
- C. An accessible path of travel to each spectator area is required.
- D. An unobstructed area minimum 4 feet wide in front of and on each side of the bleachers and minimum 6 feet wide at the rear of the bleachers shall be provided for accessibility.
- E. Concrete walkways shall be provided for access to the area.
- F. Companion seating for wheelchair users shall be provided within or immediately adjacent to each bleacher.
- G. All concrete shall drain away from the playing field.

15. SHADE

- A. Fifty percent (50%) of the spectator area shall be shaded by a shade structure(s) or trees within 5 years of planting.
- B. Shade provided by trees shall not interfere with field lights or player safety.

Section 2 – SOFTBALL FIELDS

1. DIMENSIONS

- A. Base length - 60 or 65 feet
- B. Infield radius - 65 feet from center of pitching rubber
- C. Pitching rubber - 50 feet from back point of home plate to front of pitching rubber
- D. Foul line to home plate - Minimum: 300 feet
- E. Centerfield to home plate - Minimum: 325 feet; Ideal: 350 feet
- F. Backstop to home plate - 25 feet
- G. Minimum setback - 75 feet from home plate; 75 feet from base to street, parking areas or other park amenities and/or structures
- H. Distance around field - 25 feet minimum flat area wide and clear of any obstructions provided around the outfield limit, except if there is a permanent outfield fence

2. INFIELD SURFACE

- A. Candlestick infield mix/Brick dust.
- B. Calcined clay may be added to mix per manufactures specifications.
- C. The infield mix shall be six inches deep.
- D. The finished grade shall be laser graded by a laser grader.

3. INFIELD EQUIPMENT

- A. Home plates, bases, base ground anchors, and pitching rubbers shall be provided at the time of construction, but shall be installed by the city.
- B. For ball diamonds with turf infields, a pitcher's mound cover and a home plate cover shall be provided.

4. INFIELD WATERING

- A. All infields shall have a manual irrigation watering system that is capable of watering all infield brick dust areas.
- B. Sufficient number of valves shall be provided depending on the available pressure and the size of the main line at the site.
- C. Sprinklers shall be installed along the perimeter of the infield area, 3/4 inch to 1 inch above the brick dust surface.
- D. The sprinkler heads shall be Rain Bird 6504 high speed stainless steel.
- E. Valves and valve boxes shall be installed at the end of the dugout fence, on the spectator side of the fence out of the path of travel and not blocking any views, Valves shall be Rain Bird GB series valves with the solenoid not wired, Valves shall be installed in rectangular valve boxes at least 14 inches by 20 inches, manufactured by Ametek, Carson, or an approved equal, and installed.
- F. Reclaimed water shall be used for all infield watering.

5. FIELD DRAINAGE

- A. A sub-grade infield drainage system that meets current regulations shall be installed for all regulation fields.

6. BACKSTOP

- A. Permanent backstop required.
- B. The back of backstop shall be centered behind the home plate and shall be 25 feet from home plate.
- C. Backstops and wings shall be 30 feet in height behind home plate and extend 90 feet parallel to the first and third base-paths, including the front of the dugouts.
- D. Backstop and wing fences shall be constructed with 6 gauge chain link.

7. CONCRETE PAD

- A. The area behind the backstop and wings, from first base to third base, shall be poured concrete as shown in the diagram below.
- B. The minimum width of the concrete pad shall be 24 feet.

8. WARM UP AREA

- A. As space permits on lighted fields, a flat and unobstructed space shall be provided near the field for two teams to warm up.

9. SCOREBOARDS

- A. This is an optional item for ball diamonds.
- B. However, all ball diamonds shall have conduit and wiring installed from the electrical panel to one outfield light pole. Light pole shall be designed with brackets to support future installation of scoreboard.

10. LIGHTING

- A. The goal is that all fields at community parks are lighted for night-time use; however, each community park site shall be evaluated for appropriateness for lighting, Lighting will be included at neighborhood park sites with athletic fields whenever possible and appropriate, when lights are provided, access for boom trucks must be provided to facilitate lamp maintenance.
- B. Lighting levels shall be per standards specified for each type of field in the sections that follow.
- C. Minimum maintained lighting levels shall be 30 foot-candles over the Infield and 20 foot-candles over the outfield.

11. DUGOUTS

- A. Dugouts shall be located along the first and third baselines, behind the backstop fence.
- B. They shall consist of concrete pads at field grade that are sloped away from the field, and surrounded by an 8 foot high 6 gauge chain link with black windscreen fabric on three sides and the top of the dugout.

- D. The windscreen fabric on top of the dugout shall be attached at a 9-foot height to the backstop wing, and at the top of the 8-foot high dugout fence, forming a "roof."
- E. The windscreen fabric on back and sides of dugout shall be attached from 18" from ground to 8' in height.
- F. The dugouts shall be 30 feet long, 10 feet wide, and equipped with a 25 foot long aluminum bench, a bat rack (on the home plate side of the dugout), latching gates to the infield swinging into the dugout and gates at each end of the dugout which swing into the dugout.

12. SEATING

- A. Spectator seating, when provided, shall consist of tiered concrete structures or portable bleachers containing five (5) rows of seating placed in an area approximately 28 feet with 14 feet.
- B. Bleachers are required on each side of the spectator area.
- C. An accessible path of travel to each spectator area is required.
- D. An unobstructed area minimum 4 feet wide in front of and on each side of the bleachers and minimum 6 feet wide at the rear of the bleachers shall be provided for accessibility.
- E. Concrete walkways shall be provided for access to the area.

13. SHADE

- A. Fifty percent (50%) of the spectator area shall be shaded by a shade structure(s) or trees within 5 years of planting.
- B. Shade provided by trees shall not interfere with field lights or player safety.

14. TRASH RECEPTACLES

- A. All trash receptacles shall be accessible to persons with disabilities and located immediately adjacent to an accessible path of travel.
- B. A sufficient number of trash receptacles shall be provided to serve the users of the park along the path of travel and/or a convenient distance from a major park amenity, but no less than one for each park.
- C. At least one trash receptacle shall be located within convenient proximity of each:
 - 1) Park building including community center and/or restroom.
 - 2) Picnic area
 - 3) Playground area
 - 4) Athletic fields and sports courts
 - 5) Entry into the park from the parking area

Section 3 – SYNTHETIC SOCCER FIELDS

1. SYNTHETIC TURF SURFACE

- A. FieldTurf Tarkett® Revolution 360© carpet at 2” monofilament fiber length w/ surelock finger coated backing. Color pantone: FT Green w/ fiber performance index: 81 min.
- B. FieldTurf Tarkett® CoolPlay© infill mix to 1-1/4” depth. 58% Silica Sand 32% Cryogenic rubber and 10% rubber encapsulated extruded cork cap.
- C. Brock® powerbase/YSR© Shockpad Aprox. 1” thick permeable polypropylene.
- D. Synthetic turf system testing requirements
 - a. The artificial grass system must maintain a G-max of less than 200 for the life of the Warranty as per ASTM F1936.
- E. The installed artificial grass monofilament FieldTurf shall have the following properties:

<u>Standard</u>	<u>Property</u>	<u>Specification</u>
ASTM D1577	Fiber Denier	14,500
ASTM D5823	Min. Pile Height	2”
ASTM D1577	Fiber Thickness	380 Microns
ASTM D5793	Stitch Gauge	3/4”
ASTM D5848	Pile Weight	36+oz/square yard
ASTM D5848	Primary Backing	8+oz/square yard
ASTM D5848	Secondary Backing	14+oz/square yard
ASTM D5848	Total Weight	58+oz/square yard
ASTM D1335	Tuft Bind (Without Infill)	8+ lbs
ASTM D5034	Grab Tear (Width)	200 lbs/force
ASTM D5034	Grab Tear (Length)	200 lbs/force
ASTM D4491	Carpet Permeability	>40 inches/hour
ASTM F1936	Impact Attenuation (Gmax)	<200
	Min. Infill Material Depth	1.25 inches
	Min. Extruded Cooling Composite	0.6lbs/square foot
	Min. Sand Infill Component	3.65lbs/square foot
	Min. Cryogenic Rubber Infill	2.0lbs/square foot
	Total Product Weight	958oz/square yard

Variation of +/- 5% on above listed properties is within normal manufacturing tolerances

2. SYNTHETIC TURF BASE PREPARATION

- A. A licensed geotechnical engineer familiar with synthetic turf construction and local experience shall provide synthetic turf base and subgrade recommendations.
- B. Recommendations should cover the following items:
 - a. Depth of custom modified class II permeable base and three reputable suppliers of that material, in proximity to the project
 - i. Min. and Max. Compaction requirements of base material(s)
 - b. Existing subgrade preparation and compaction
 - i. Including or excluding lime or cement treatment

- c. Any recommended geotextiles, filter fabrics or soil stabilizers.
- C. Synthetic Turf Permeable Base rock of crushed aggregate with min. gradation and characteristics meeting the requirements of a custom modified Class 2 permeable base aggregate complying with the specific gradation shown below:

<u>Sieve Size</u>	<u>Percentage Passing</u>
1"	100
3/4"	80-100
3/8"	30-50
No. 4	25-40
No. 8	10-30
No. 30	7-25
No. 40	5-17
No. 50	0-7
No. 200	0-3

- D. Laboratory testing of samples prior to submitting custom modified class 2 permeable base material for review by the design team.

<u>Test Method</u>	<u>Criteria</u>
a. LA Abrasion Test (ASTM c 131)	Not to Exceed 40
b. Sulfate Soundness Test (ASTM C 88)	Not to exceed 12% loss
c. Permeability of Granular Soils (ASTM D 2434-68)	24" Per hour Min.
d. Particle size and gradation (ASTM D 6913)	Per section 3 Sieve analysis

- E. Laboratory testing of material delivered onsite and in place.

<u>Test Method</u>	<u>Criteria</u>
a. LA Abrasion Test (ASTM c 131)	Not to Exceed 40
b. Permeability of Granular Soils (ASTM D 2434-68)	24" Per hour Min.
c. Particle size and gradation (ASTM D 6913)	Per section 3 Sieve analysis

- F. Laboratory testing of material Installed in place per the contract documents.

<u>Test Method</u>	<u>Criteria</u>
a. Permeability of Granular Soils (ASTM D 2434-68)	24" Per hour Min.
b. Particle size and gradation (ASTM D 6913)	Per section 3 Sieve analysis
c. Compaction testing (ASTM D 698)	Per Geotechnical Engineer

- G. Onsite testing of material Installed prior to placement of Synthetic Turf

<u>Test Method</u>	<u>Criteria</u>
a. Permeability of base stone (ASTM F 2898-11)	15" Per hour Min.
b. Particle size and gradation (ASTM D 6913)	Per section 3 Sieve analysis

- H. Onsite testing of material Installed after placement of Synthetic Turf

<u>Test Method</u>	<u>Criteria</u>
a. Infiltration rate of synthetic turf (ASTM D 3385-09)	24" Per hour Min.

3. SYNTHETIC TURF DRAINAGE

- A. An impermeable liner below the custom modified Class II permeable base is required unless indicated otherwise by the geotechnical engineer.
 - a. A 30 mil HDPE liner shall be installed with heat welded and thermally fused seams.
- B. ADS AdvanEdge 1"x12" flat drains w/ filter sleeves shall be installed 15'-20' O.C. or as directed by the project civil engineer.

- a. Flat Panel Drains shall connect to large perimeter Storm Drain trenches with a min. holding capacity of a 10yr storm event or as directed by the project Civil engineer.
- C. Perimeter Storm Drain pipe.
 - a. 4" through 10" solid wall and perforated drainpipe shall be smooth interior wall conforming to AASHTO M252
 - b. 12" through 36" solid wall and perforated drainpipe shall be smooth interior wall conforming AASHTO M294 Type S.
- D. Perimeter Drainage Trench.
 - a. Shall be contained by the impermeable liner or as recommended by the geotechnical engineer.
 - b. 1/2 inch crushed aggregate drain rock for encasing perforated drainage piping consisting of clean, washed, virgin, well-graded, crushed stone, free of shale, clay, organic materials, and debris shall fill the entire perimeter trench compacted and installed in lifts as directed by the geotechnical engineer.
 - a. Drain rock shall be wrapped in Mirafi 140N filter fabric or as recommended by the geotechnical engineer.
 - c. Comply with the testing requirements of aggregate material under synthetic turf.
- C. Leveling Course: 3/8 inch virgin crushed aggregate rock for leveling above the perimeter trench consisting of clean, washed, virgin, well-graded, crushed stone, free of shale, clay, organic materials, and debris.
 - a. Provide leveling course for top 2" above perimeter drainage trenches directly below the shockpad.
 - b. Comply with testing requirements of aggregate material under synthetic turf.

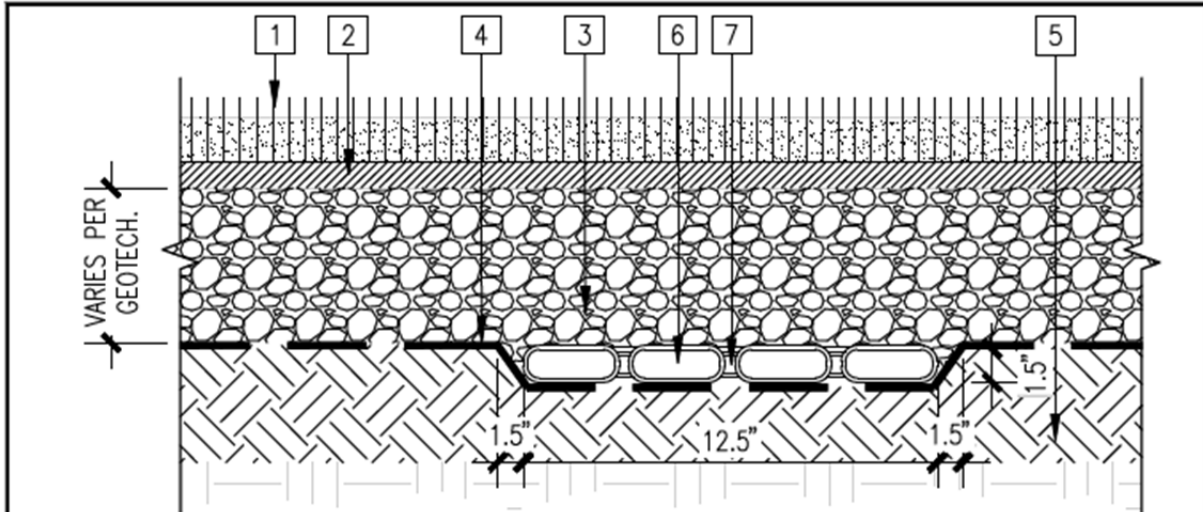

- 1 SYNTHETIC TURF SYSTEM, FIELDTURF® REVOLUTION 360® "CARPET" W/ COOL PLAY® INFILL PER PARK AMENITY DESIGN STANDARD SPECIFICATIONS CHAPTER 4, SECTION 3 OR APPROVED EQUAL FOR SYNTHETIC TURF SOCCER FIELDS
- 2 COMPOSITE SHOCK PAD, BROCK® POWERBASE/YSR® PER PARK AMENITY DESIGN STANDARD SPECIFICATIONS CHAPTER 4, SECTION 3 OR APPROVED EQUAL FOR SYNTHETIC TURF SOCCER FIELDS
- 3 CUSTOM MODIFIED CLASS 2 PERMEABLE AGGREGATE BASE MOISTURE CONDITIONED & COMPACTED PER GEOTECHNICAL ENGINEER
- 4 POLYFLEX® 30 MIL. HDPE IMPERMEABLE LINER OR APPROVED EQUAL WITH HEAT WELDED/THERMALLY FUSED SEAMS WITH A 24" OVERLAP MIN.
- 5 SUBGRADE MOISTURE CONDITIONED AND COMPACTED TO THE REQUIRED RELATIVE DENSITY PER THE GEOTECHNICAL ENGINEER.
- 6 FLAT PANEL DRAIN, 1" X 12" ADS ADVANEDGE® DRAINS W/ FILTER FABRIC SLEEVES TRENCHED INTO SUB-GRADE
- 7 SECURE FLAT PANEL DRAIN SYSTEM PER MANUF. RECOMMENDATIONS

NOTE:

- A: SLOPE COMPACTED SUBGRADE FOR SYSTEM 0.5%–0.75% TO PERIMETER SUBDRAINS, PER CIVIL
- B: ANY SUBSTITUTION REQUEST SUBMITTED AS AN "OR EQUAL" SHALL MEET THE REQUIREMENTS OF THE SPECIFICATIONS AS WELL AS THE MATERIAL TYPES AND PERFORMANCE STANDARDS OF THE SPECIFIED SYSTEM, INCLUDING BUT NOT LIMITED TO: 1) INFILL MATERIAL TYPE, CHARACTERISTICS, DEPTHS, QUANTITIES AND PERCENTAGES, 2) DENSITY, MINIMUM GAUGE, LENGTH AND TYPE OF FIBER, 3) BACKING MATERIALS AND COATINGS, 4) PERCOLATION RATES OF THE BACKING AND OVERALL SYSTEM, 5) DRAINAGE 6) WARRANTEE TYPE, LIMITATIONS, COVERAGE AND DURATIONS, 7) UV RESISTANCE, 8) SHEER STRENGTH AND TUFT BIND, 9) SEWN SEAMS, 10) ROLL LAYOUT AND PATTERNS 11) ALL OTHER CHARACTERISTICS OF THE SPECIFIED SYSTEM.



DRAWN BY: C. LINDSAY
 CHECKED BY: D. SEALE
 APPROVED BY: J. TEIXEIRA
 DATE: MARCH, 2018

SOCCER FIELD
 SYNTHETIC TURF SYSTEM
 CITY OF SANTA CLARA

AF-1

CHAPTER 4
 SECTION 3

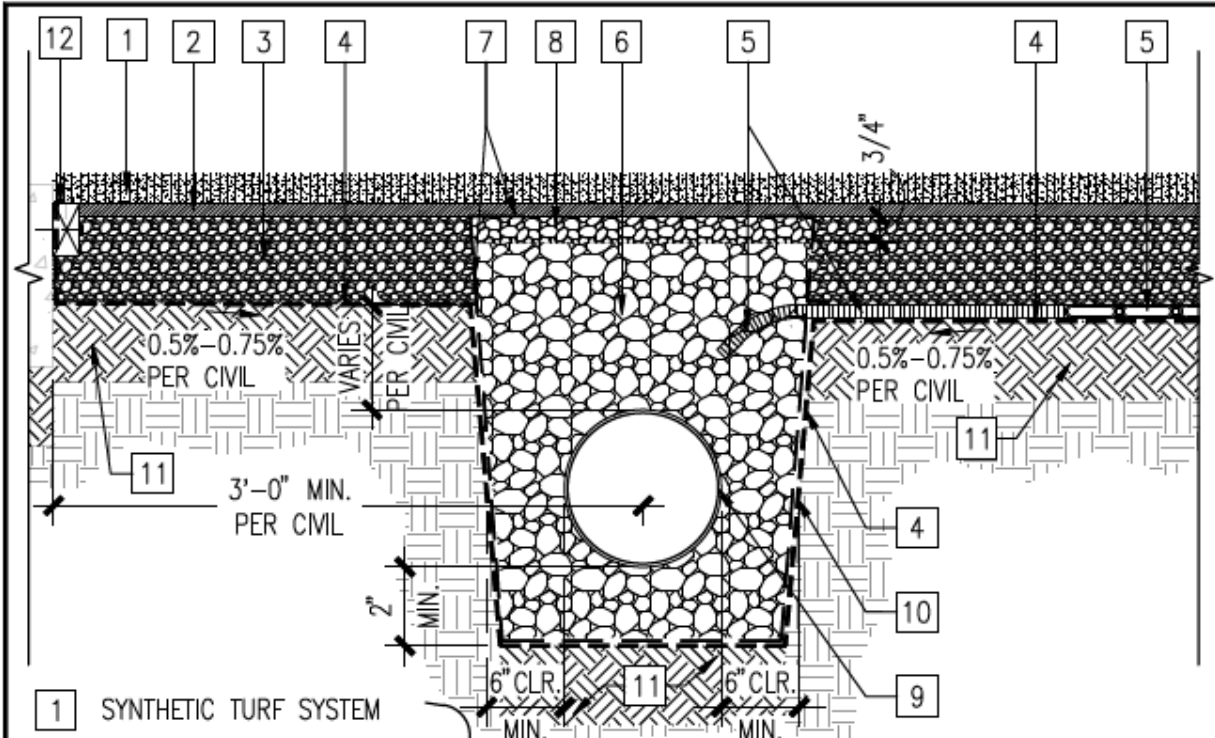

- 1 SYNTHETIC TURF SYSTEM
- 2 SHOCK PAD
- 3 CUSTOM MODIFIED CLASS 2 PERMEABLE AGGREGATE BASE
- 4 IMPERMEABLE LINER
- 5 FLAT PANEL DRAINS, LAP INTO DRAINAGE TRENCH, TYP
- 6 3/4" MINUS WASHED DRAIN ROCK COMPACTED PER GEOTECHNICAL
- 7 WRAP DRAIN ROCK W/ MIRAFLI 140N FILTER FABRIC AND LAP 6" OVER THE TOP OF THE LEVELING COURSE FREE FROM WRINKLES, TYP
- 8 LEVELING COURSE, 3/8" MINUS WASHED DRAIN ROCK COMPACTED TO ALLOW FOR DRAINAGE AND PREVENT ALL SETTLING
- 9 PERFORATED DRAIN PIPE. SLOPE AND SIZE PER CIVIL ENGINEER
- 10 BATTER SIDES OF TRENCH
- 11 COMPACTED SUBGRADE PER GEOTECHNICAL
- 12 2x4 TREX HEADER SECURED W/ 1/4x4 SIMPSON STRONG TIE BLUE TITEN FASTENERS 18" O.C.

NOTE:
 A: ADHERE IMPERMEABLE LINER AROUND ADDITIONAL PENETRATIONS W/ WATER TIGHT SEALS, TYP.
 B: ANY SUBSTITUTION REQUEST SUBMITTED AS AN "OR EQUAL" SHALL MEET THE REQUIREMENTS OF THE SPECIFICATIONS AS WELL AS THE MATERIAL TYPES AND PERFORMANCE STANDARDS OF THE SPECIFIED SYSTEM, INCLUDING BUT NOT LIMITED TO: 1) INFILL MATERIAL TYPE, CHARACTERISTICS, DEPTHS, QUANTITIES AND PERCENTAGES, 2) DENSITY, MINIMUM GAUGE, LENGTH AND TYPE OF FIBER, 3) BACKING MATERIALS AND COATINGS, 4) PERCOLATION RATES OF THE BACKING AND OVERALL SYSTEM, 5) DRAINAGE 6) WARRANTY TYPE, LIMITATIONS, COVERAGE AND DURATIONS, 7) UV RESISTANCE, 8) SHEER STRENGTH AND TUFT BIND, 9) SEWN SEAMS, 10) ROLL LAYOUT AND PATTERNS 11) ALL OTHER CHARACTERISTICS OF THE SPECIFIED SYSTEM.

	DRAWN BY: C. LINDSAY	SYNTHETIC TURF PERIMETER DRAIN SYSTEM	AF-2
	CHECKED BY: D. SEALE		
	APPROVED BY: J. TEIXEIRA		
	DATE: JANUARY, 2018		
CITY OF SANTA CLARA		CHAPTER 4 SECTION 3	

Chapter 5 – Playgrounds

Section 1—PLAYGROUNDS

1. DEFINITION

- A. Safety is a high priority for design of children's playgrounds in the City of Santa Clara. The utmost attention should be devoted to providing safe equipment for children.
- B. Playground design must include a minimum of five (5) of the six (6) + 1 elements of play in the overall design and layout of the playground. The six (6) + 1 elements of play include: climbing, balancing, spinning, brachiating, swinging, sliding and running/free play/imagination.
- C. The minimum size of a playground should be at least 3500 square feet. Playgrounds shall be age-separated when space allows, with playgrounds for ages 2 to 5 years separated from playgrounds for ages 5 to 12 years.

2. STATE AND FEDERAL STANDARDS

- A. Conform to California Health and Safety Code Sections 115725 through 115735. All new playgrounds open to the public are required to:
 - 1) Conform to the current playground standards set by the American Society on Testing and Materials (ASTM).
 - 2) Conform to the current playground guidelines published by the United States Consumer Product Safety Commission (CPSC).
 - 3) Comply with the current California Building Code with errata (Title 24, California Code of Regulations) and the U.S. Access Board's Accessibility Guidelines for Play Areas.
 - 4) Meet Americans with Disabilities Act (ADA) standards.
 - 5) Comply with all Federal, State and local guidelines.

3. PLAYGROUND PLANS

- A. Playground plans shall be submitted to the City for review and approval. An approved Playground Plan is required prior to the issuance of building permits prior to start of construction of the playground, if building permits.
- B. The playground plan submittal shall include:
 - 1) To scale diagram of playground layout, no smaller than 1" ~ 20'
 - 2) Dimensioned safety use zones around each piece of equipment, per manufacturer's specifications
 - 3) Deck, platform and step heights for each component.
 - 4) Play type for each component.
 - 5) Manufactures and model numbers of each piece of equipment and each type of surfacing (specifications for play equipment may be requested).
 - 6) Age group that the play equipment is designed to serve.
 - 7) Detailed contact information for the manufacturer.

- 8) Location of ADA accessible path(s) of travel and access point(s) to the equipment (transfer platform).
- 9) A chart comparing the required number of accessible play components and the number of proposed accessible play components shall be provided.
- 10) Details on installation of safety surfacing, including section view with minimum depth of safety surfacing and type of surfacing.
- 11) Method of drainage of safety surfacing.

4. CERTIFICATION OF PLAYGROUND

- A. Prior to issuance of Certificate of Use and Occupancy for the playground, the Contactor shall submit to the City, a letter stating that the play equipment has been inspected by a person authorized by the manufacturer, that the equipment has been installed according to the manufacturer's specifications, and that it complies with the minimum playground safety regulations adopted by the State of California Health and Safety Code Sections 115725 through 115735).
- B. The City reserves the right to have a Certified Playground Safety Inspector review the playground site for safety, compliance and proper fit within the designated playground area.

5. ADDITIONAL PLAYGROUND STANDARDS

- A. In addition to State and Federal requirements, all playgrounds shall be subject to the following standards:
 - 1) When two or more playgrounds are provided on one site, there should be a distinct separation between preschool age playgrounds (2-5 years) and school age playgrounds (5-12 years) using walkways, seating areas or landscaped buffers to separate the two distinct areas.
 - 2) Metal slides or merry-go rounds are not allowed.
 - 3) A variety of play experiences and graduated play challenges should be provided. A matrix showing body movement opportunities is included in Table 2.0. It is a goal that as many movement opportunities be provided within the available space as possible.
 - 4) The edge of the playground safety surfacing should be located a minimum of 50 feet in all directions from any hazards such as streets, parking lots bike paths, barbecue grills and tripping hazards. A minimum 3-foot high fence, wall, solid hedge or other barrier deemed acceptable by the City staff may serve as protection if the distance required cannot be met.
 - 5) The playground shall be visible from the street or parking lot for surveillance.
 - 6) A minimum of one shaded seating area shall be provided nearby to foster adult supervision of children. Preference should be given to natural shade by trees.
 - 7) All playground equipment shall be certified by the International Playground Equipment Manufacturers Association (IPEMA).

6. MAINTENANCE RELATED DESIGN STANDARDS

In addition to the above design standards for all playgrounds, playgrounds in public parks shall be subject to these additional standards which reduce maintenance, costs, while improving the sustainability and longevity of the playground and providing added value.

- A. Play equipment shall not be composed of wood materials. Materials resembling the look of wood, such as recycled plastic lumber, are allowed.
- B. Impact attenuation surfacing for playground surfacing shall be incorporated into the playground design based on the following order of preference.
 - 1) Engineered wood fiber safety surfacing
 - 2) Poured in place rubberized safety surfacing
 - 3) Wash silica type sand
- C. The poured in place surfaces should be designed to:
 - 1) Minimize the amount of poured-in-place surfaces except for areas required by ADA accessibility and safety fall zone compliance,
 - 2) Adjust the depth of the subsurface and softness of the poured-in-place to the needs of the play equipment.
 - 3) Minimize the depth/softness outside of the fall zones in order to minimize wear and tear of the surface.
 - 4) Avoid narrow areas of sand (under 6 feet wide) and sand areas with angles under 90 degrees, to allow the sand to be roto-tilled on a regular basis without damaging the adjacent poured-in-place. Sand should only be used in designated sand play areas away from poured in place surface.
 - 5) Use a combination of standardized colors (such as 25% black, 25% green, and 50% tan), rather than a single solid color, so that color mixtures can be adjusted to match faded colors in the future for patching and repairs.
 - 6) If the surface has shapes or patterns, use simple geometric shapes that are easy to patch.
 - 7) Avoid any patterns or shapes under high-traffic areas like swings and the base of slides since these areas are patched frequently.
- D. All new public parks should have swings within the playground area whenever practical. When replacing or rehabilitating existing playgrounds, the goal is to provide swings unless space limitations exist. It is preferred that both belt swings for the 5-12 year age group, and tot swings (swings to be used with adult assistance) for the 4 years and under age group be provided, if space allows. If space is available the use of adult/tot combo swings such as the Expression Swing or the Baby and Me swing could also be used.
- E. Tube slides or structures are discouraged because of potential public safety issues
- F. All drinking fountains shall be located at least 50 feet from the edge of any sand play areas
- G. All playgrounds shall have nighttime security lighting to prevent vandalism
- H. All public play equipment shall be of high quality materials designed to be vandal resistant, and shall have a demonstrated record of durability and availability of parts. All equipment shall have a minimum warranty of 5 years.
- I. A sand area should be provided within the 2-5 year playground, if possible, to allow for unstructured sand play.
- J. Playground sand shall be washed silica type white sand (or equivalent), uniform in grain size and designed for use in children's play areas. Contractor shall provide a minimum of three samples from varied sources that best meet these guidelines for review and approval prior to purchase and placement of any sand in the playground areas as indicated in construction plans. Sand shall meet the following ASTM C136-84a test for fine white sand as shown in Table 1.0 below:

Table 1.0

Screen Size	Percent Passing Through
#16	100%
#30	98%
#50	62%
#100	17%
#200	0-1%

Table 2.0

Activities	Vestibular	Climbing	Balance	Upper Body	Push/Pull	Crawling/ Bilateral	Fantasy/ Social
Balance Beams			*				
Balance Ropes			*		*		
Binoculars/Telescope							*
Bridge (Moving)	*		*				*
Chinning Bars	*			*	*		
Fire Poles	*	*		*			
Game Panels							*
Horizontal Bars						*	
Jumping Boards	*		*		*		
Ladders		*	*		*	*	
Nets		*	*	*		*	
Parallel Bars				*	*		
Platforms		*					*
Playhouses, etc.							*
Rings	*				*	*	
See Saws	*						
Sensory Gardens							*
Slides	*						
Sound Tubes							*
Spring Riders	*		*	*			
Stairs		*					
Steering Wheels							*
Swings	*				*		
Theme Design							*
Track Ride	*	*			*		
Tunnels						*	*
Turning Bars	*	*			*		

Chapter 6—Play Courts (In progress)

Section 1 – OUTDOOR BASKETBALL COURT

1. DIMENSIONS

- A. Playing area - 84 feet by 50 feet for full court; 47 feet by 50 feet for half court.
- B. Setback - Court surface shall extend a minimum of 5 feet around the entire playing field and a minimum of 10 feet between 2 courts that are placed side -by-side.
- C. Court Gradient - 1.0 to 1.5 percent along the width (shortest dimension) of the court.
- D. Parks & Recreation may also go with a nonstandard court to be determined by type of Parks & Recreation activities planned for that specific park.

2. SURFACE

- A. Courts (including the 5' safety zone) shall have a poured concrete surface with a medium broom finish to prevent slipping.

3. PLACEMENT

- A. A minimum distance of 10 feet shall be provided between courts that are placed side-by-side or end-to-end
- B. When there is a light pole between the courts, the minimum distance shall be 17'1" (which includes 13" for the width of the pole and 8' clear on each side between the light pole and the court).
- C. Where two or more courts are provided at one site, the courts should be configured for multi-purpose use, per Basketball Court Placement Diagram on page 15.

4. MARKINGS

- A. All markings on the playing surface shall be applied as shown below, using a wear-resistant, colored substance.
- B. All lines shall be a minimum of 2 inches wide, unless otherwise noted.
- C. The color of the markings shall be determined during the final design.

5. GOALS

- A. Permanent installation
 - 1) Bison Mega Duty Basketball Unit
 - a. Steel rectangular backboard 42" x 60"
- B. Removable installation
 - 1) Captain Internal Acrylic HD Breakaway
 - a. Backboard 32" x 60" breakaway rim

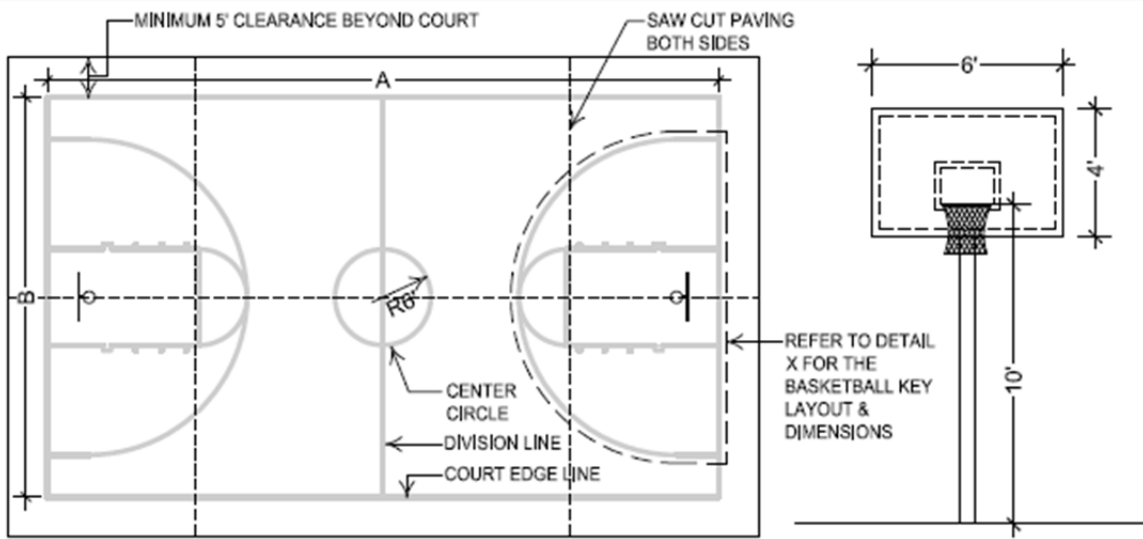

BASKETBALL COURT (FULL)
 PLAN VIEW
 SCALE: 1" = 20'

POST, BACKBOARD, NET & RIM

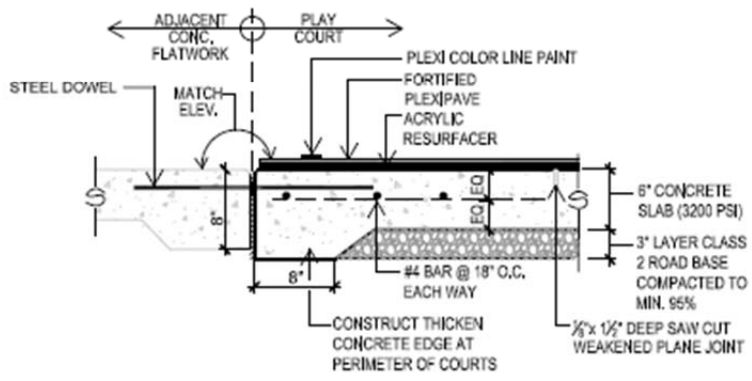

1c COURT PAVING
 3/4" = 1'-0"

COURT EQUIPMENT
 BASKETBALL

PRODUCT: x
 MODEL No.: x
 POST & SUPPORT MEMBER FINISH: x
 CONTACT: x
 PHONE: x
 INSTALLATION NOTE: x

BASKETBALL COURT DIMENSIONS			
	YOUTH	HIGH SCHOOL	COLLEGE
A	74'	84'	94'
B	42'	50'	50'
R	19,75'	19,75'	20,75'

- NOTES:
1. ALL COURT LINES TO BE 2" THICK SURFACE PER SPECS.
 2. SURFACE PER SPECS.
 3. INSTALL REGULATION BACKBOARD, HOOP AND NETTING. POLE INSTALLATION PER MANUFACTURER SPECS.
 4. 5' PLAY ZONE AROUND COURT, 10' MINIMUM TO ADJACENT COURTS.

BASKETBALL COURT TYPICAL LAYOUT (FULL)



SANTA CLARA SPORT COURTS STANDARD PLANS	BASKETBALL COURT (FULL)	
	HARDCOURT DETAILS	DETAIL NO. XX

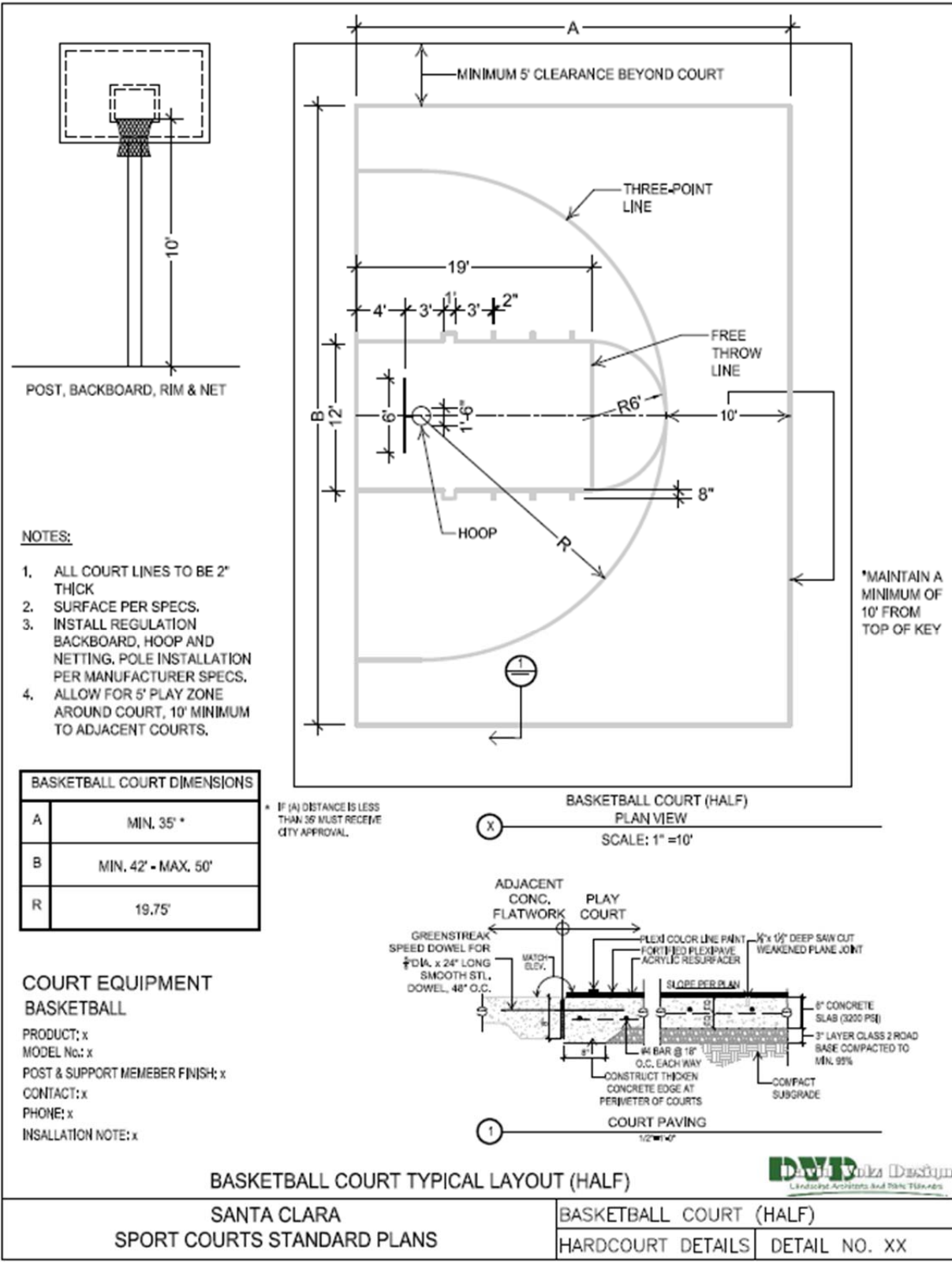

Section 2 – TENNIS COURTS

1. DIMENSIONS
 - A. Playing Area: 36 feet by 78 feet
 - B. Safety Zone Clearance
 - 1) 12 foot side clearance on each side and 21 feet between each baseline and the fence.
 - 2) For public parks, the concrete shall extend 18 inches out beyond the fence around each court (or courts if more than one) to reduce court maintenance.
 - C. Court Gradient: acceptable gradient range for tennis courts is 0.5 to 1.0 percent, with a cross slope.

2. ACCESSIBILITY
 - A. Tennis court gates or fence openings shall be ADA accessible.

3. GATES
 - A. Courts in public parks shall have a double gate at the end of each court for maintenance access.

4. ORIENTATION
 - A. Courts should be laid out on a north-south axis line.

5. COURT PLACEMENT
 - A. When two *or* more courts are placed side-by-side, the minimum distance between adjacent sidelines of the courts shall be 12 feet.
 - B. A fence, 42 inches high, shall be placed midway between each two adjacent courts, beginning at a 46-inch gate opening at each end.
 - C. The minimum distance between the end of each court and the fence shall be 21 feet.

6. COURT SURFACE
 - A. Hot Mix Asphalt Tennis Courts
 - 1) Materials
 - a. A base course of bituminous concrete mixture; crushed aggregate; processed/recycled asphalt or processed/recycled concrete should be installed over the subgrade.
 - b. The specified material should meet applicable ASTM specifications.
 - c. Compacted thickness will depend on local soil and climatic conditions, but in no case should the thickness be less than the equivalent of 4" of thoroughly compacted crushed stone.
 - 2) Spreading and Compacting
 - a. The material should be spread by methods and in a manner that produces a uniform density and thickness.
 - b. The materials thus spread should be compacted to 95% minimum Proctor Test with equipment that provides uniform density.

- 3) Tolerances
 - a. Surface of the base course as compacted should not vary more than 1/2" from the true plane of the court.
- B. Intermediate Pavement Course
 - 1) A leveling course of a hot plant mix having a maximum aggregate size of 3/8" to 3/4" in accordance with specifications of the state's Department of Transportation and/or the Asphalt Institute should be constructed over the base course to a compacted thickness of not less than 1 1/2".
 - 2) This hot plant mix should be spread and compacted by methods and in a manner that produces a uniform density and thickness.
 - 3) The finished intermediate course should not vary more than 1/4" in 10', when measured in any direction.
- C. Asphaltic Surface Course
 - 1) General Description
 - a. A surface course of a hot plant mix having a maximum aggregate size of 3/8" and a minimum aggregate size of 1/4" should be constructed over the hot mix intermediate course to a compacted thickness of not less than 1".
- D. Epoxy-bonded colored surface.
 - 1) To current USTA standard court colors. To be approved by the City

7. MARKINGS

- A. The courts shall have markings for singles, doubles and 10-and-under play.
- B. Baseline shall be painted 4 inches wide.
- C. All other lines shall be painted 2 inches wide.

8. FENCING

- A. 12 foot high 6-gauge chain link fence shall enclose the entire court.
- B. Fence material shall be galvanized.
- C. The courts shall be shielded with an open mesh windscreen of black seamless polypropylene 9 feet high with center tabs.

9. BENCHES

- A. Two benches for players shall be located adjacent to each court.
- B. A bench for patrons waiting to use the courts shall be placed adjacent to the perimeter gate.
- C. Type of bench to be approved by the City

10. TRASH CANS

- A. One trash can to be located outside the perimeter gate & adjacent to each court.

11. LIGHTING

- A. Lighting to be determined by location of courts and planned recreational activities.
- B. The minimum maintained lighting levels shall be 50 foot-candles at the net line and 30 foot-candles at the end lines.

12. HOSE BIB

- A. One hose bib shall be provided for every two courts.
- B. Hose bibs shall be located so that water flows away from the hose bibs when hosing down the courts (on the high side of the slope).
- C. Hose bibs shall be of a larger sufficient size with pressure to allow washing courts.
- D. Preference to use recycled water if available.

NOTES:

1. ALLOW FOR 21 FEET BETWEEN COURT AND BACKSTOP (FENCE). ALLOW FOR 12 FEET BETWEEN ADJACENT COURTS.
2. ALL COURT LINES TO BE 2 INCHES WIDE AND WHITE OR BLUE.
3. COURT SURFACING PER SPECIFICATIONS.
4. NETTING PER SPECIFICATIONS.
5. SLAB DESIGN MIN. 6" THICK CONCRETE WITH #4 REBAR @ 18" O.C. REQUIRES ENGINEERS SIGNATURE.

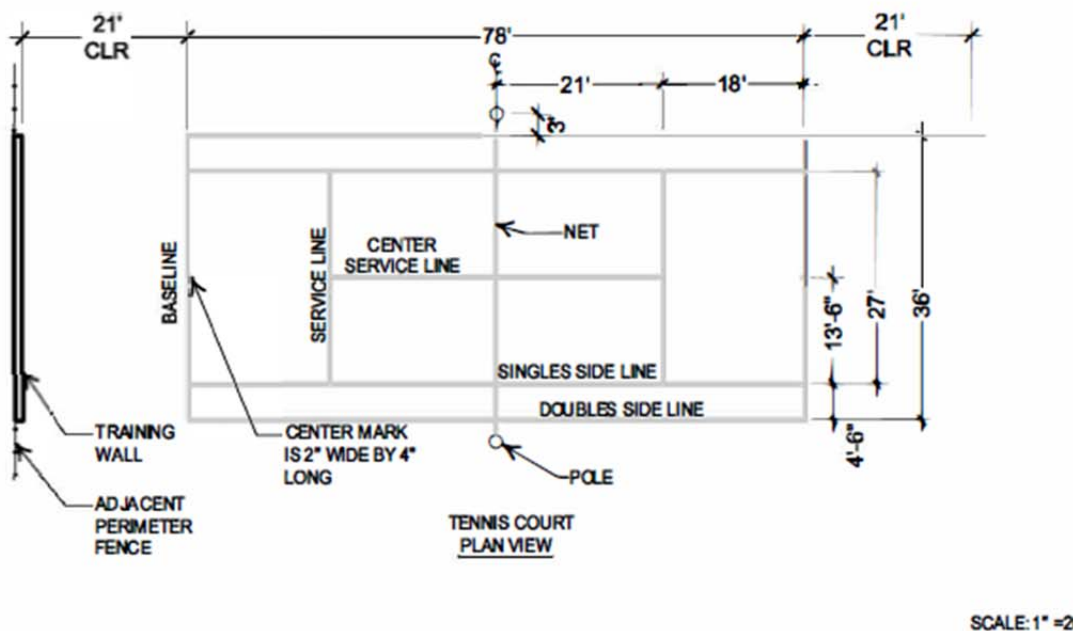
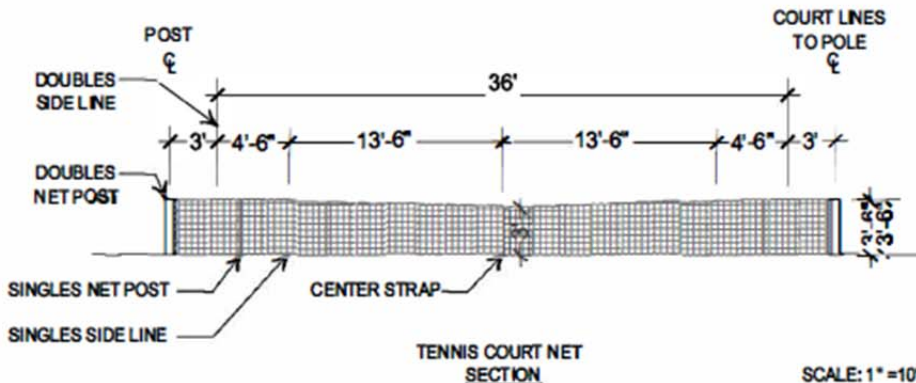
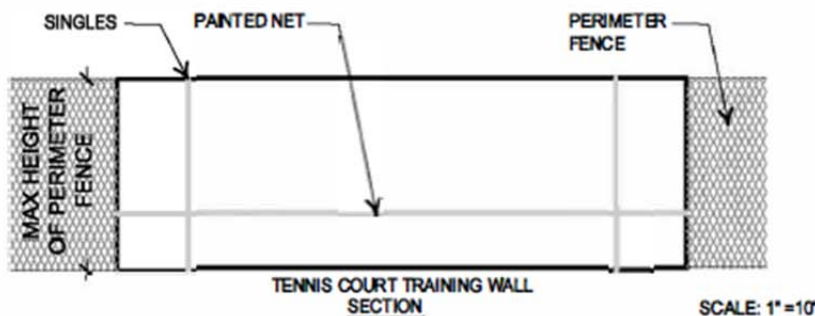

TENNIS COURT WITH ONE BALL WALL TYPICAL LAYOUT

SANTA CLARA SPORT COURTS STANDARD PLANS	TENNISCOURT (Single) CHAPTER 6, SEC 2	
	HARDCOURT DETAILS	DETAIL NO. TC-1

(Chapter 7—Miscellaneous (In progress))

Chapter 8 – New Public Park Design, Review & Approval Process

Section 1 – BACKGROUND

1. SANTA CLARA CITY GENERAL PLAN
 - A. Goals: The City General Plan identifies various parks, open space and recreation goals that apply to developments such as 5.9.1-G1 through 5.9.1-G4 that recommends new parks (land) and recreational opportunities be provided with the new development.
 - B. Policies: The City General Plan identifies various parks, open space and recreation policies that also apply to developments such as 5.9.1-P1 through 5.9.1-P21 that indicate new parks should serve the needs of the surrounding neighborhood and overall community.

2. SANTA CLARA CITY CODE CHAPTER 17.35
Effective September 13, 2014, Santa Clara City Code Chapter 17.35 requires every person who constructs or causes to be constructed a dwelling unit or dwelling units or who subdivides residential property to provide adequate park and recreational facilities, and/or pay a fee in-lieu of parkland dedication (at the discretion of the City) pursuant to the Quimby Act (Quimby) and/or Mitigation Fee Act (MFA) provisions.

According to City Code 17.35, projects may submit a request for credit for eligible on-site private parkland and recreation amenities dedicated to active community recreational use and can satisfy up to half of its total parkland obligation as approved by the City. ***Read Santa Clara City Code Chapter 17.35 in its entirety for all of the requirements.***

- A. 17.35.070(a), the calculation of private open space shall not include features required to be included by zoning and building codes and other applicable laws, including but not limited to existing easements for other public purpose, yards, patios, paseos, court areas, setbacks, sidewalks, decorative landscape areas required with residential site design and other open areas. Per the building code and fire safety, there is a setback requirement of at least 4 feet from a building. A buffer strip/setback of at least 4 feet between private amenities and public parkland should also be deducted from the area calculation.
- B. 17.35.070(b), the private open space shall be devoted to “**Active Recreational Use**”. The private ownership and maintenance of the open space shall be restricted for such use by a recorded written agreement, conveyance, covenant or restrictions. Such document shall be subject to the prior review and approval of the City Attorney, and any future proposed amendments must be first submitted to the City Attorney for approval prior to adoption.
- C. 17.35.070(c), Developer must propose and agree to design and construct the necessary recreational and park facilities and improvement associated with each element of the private open space set forth. The space shall be reasonably adapted for use for recreational purposes, taking into consideration such factors as size, shape, topography, geology, access and location.

- D. 17.35.070(d), facilities proposed for the open space shall be in substantial compliance with the provisions of the Parks, Open Space, and Recreation Goals and Policies of the General Plan.
- E. 17.35.070(e), the developer shall supply a covenant to maintain the open space to the City Attorney prior to approval of the final subdivision map for review and approval.
- F. 17.35.070(f), to qualify for credit, the private open space in a new development must contain at least four (4) of the following eight (8) elements:
 - 1) Minimum one-half (0.50) acre of play field – open, natural turf area, comprised of a single unit of land, which is generally free of physical barriers which would inhibit group play activities, with a minimum contiguous area of one-half (0.50) acres;
 - 2) Children’s play apparatus - separate play areas for ages 2-5 & ages 5-12 with the inclusion of the 6+1 key elements of play and physical activity: balancing, sliding, swinging, brachiating, spinning, climbing and running/free play/imagination;
 - 3) Landscaped and furnished, park-like quiet area;
 - 4) Recreational community gardens;
 - 5) Family picnic area;
 - 6) Game, fitness or sport court area;
 - 7) Accessible swimming pool (minimum size 42’ × 75’) with adjacent deck and lawn areas;
 - 8) Recreation center buildings and grounds.
- G. 17.35.070(g)(1), these elements must equal a minimum of 0.75 acres, or 32,670sf, of private open space.
- H. 17.35.070(g)(2), Developer must attest that every resident has equal access to every feature in every building and not be restricted to the recreational elements and amenities in the building they reside. If limited access is proposed, the credit value can only be applied against the park fee obligation generated by those residents with access to the said recreation area.
- I. 17.35.070((g)(3), irregularly shaped pieces of property of less than optimum utility or burdened by topographic consideration that render them unsuitable for “**Active Recreational Use**” shall not be eligible for credit.
- J. 17.35.070(h), housing developments in which 100% of the units are affordable to low- and/or moderate-income households, and senior housing developments are eligible for an additional 15% credit toward the parkland dedication requirement.

Section 2 – REQUIREMENT TO PROVIDE PARK AND RECREATIONAL FACILITIES

1. PUBLIC PARKLAND DEDICATION

- A. Focus: “Neighborhood and Community parkland” and “**Active Recreational Use**” as required by Chapter 17.35.
 - 1) Neighborhood parks are 1 – 15 acres in size.
 - 2) Community parks are over 15 acres in size.
 - 3) “**Active Recreational Use**” is the activity that requires the use of organized play areas, including, but not limited to, softball, baseball, football and soccer fields, tennis and basketball courts, fitness stations and various forms of children’s play equipment.
- B. Types
 - 1) Fee Title – preferred.
 - 2) Public Easement – less preferable, only when it serves public interest. Requires findings.
- C. Parkland Dedication Standard shall mean:
 - 1) The acreage of park and recreational facilities to be provided per 1,000 City residents from any person who constructs or causes to be constructed a new residential development or who subdivides residential property.
 - a. The parkland dedication standard per Quimby provisions is 3.0 acres per 1,000 City residents.
 - b. The parkland dedication standard per MFA provisions is 2.53 acres per 1,000 City residents.
- D. All features and amenities in the public parkland must be in substantial compliance with The Americans with Disabilities Act, Federal, State and Local Regulations, as well as Park Standards, where the Department’s determination is final.
- E. Development of specific language in a Planning document and Project “condition of approval” describing the parcel(s), the park(s) and the Elements to be dedicated to the City which will be included in a legally binding document recorded with the County Clerk-Recorder’s Office;
- F. Development of specific language for a legally binding document(s) that is applicable to each Project describing the parcel(s), the park(s) and the Elements (per Ch. 17.35) such as:
 - 1) Development Agreement
 - 2) Maintenance Agreement – public parkland to be maintained to the City’s standards as a minimum and should include the specified timeframe (i.e. 40 years)
 - 3) Insurance Agreement - to cover the City’s interest
 - 4) Covenants, Conditions & Restrictions (CC&Rs)
 - 5) Homeowner’s Association Documents (HOA)
- G. Public Parkland Dedication (Fee Title & Public Easement):
 - 1) Description of the parcel(s), park name(s) and square footage will be described and identified on the final map and recorded with the County Clerk-Recorder’s Office.
- H. Area calculation:
 - 1) shall not include features required to be included by zoning and building codes and other applicable laws, including but not limited to existing easements for other public purpose, yards, patios, paseos, court areas, setbacks, sidewalks, decorative landscape areas required with residential site design, etc.
 - 2) Per the building code and fire safety, there is a setback requirement of at least 4 feet from the building that should be deducted from the area calculation. In addition, a buffer

strip/setback of at least 4 feet between private amenities and the public park/parkland is to be deducted from the area calculation.

I. City Park Standard Practice

- 1) Wayfinding signs.
- 2) Public access from a public right of way to all public parks.
- 3) Parking for park visitors.
- 4) Restroom facilities if there is more than 1 hour of play value.

2. PRIVATE ON-SITE PARKLAND AND RECREATIONAL AMENITIES

A. Must contain at least four (4) of the eight (8) specified community and neighborhood park elements:

- 1) Open, natural turf area, comprised of a single unit of land, which is generally free of physical barriers which would inhibit group play activities, with a minimum contiguous area of one-half (0.50) acres.
- 2) Children's play apparatus – separate play areas for ages 2-5 and ages 5-12 with the inclusion of the 6+1 key elements of play and physical activity: balancing sliding, swinging, brachiating, spinning, climbing and running/free play/imagination.
- 3) Landscaped and furnished park-like quiet area.
- 4) Recreational community gardens.
- 5) Family picnic area.
- 6) Game, fitness or sport court area.
- 7) Accessible swimming pool (minimum size 42' x 75') with adjacent deck and lawn areas.
- 8) Recreation center buildings and grounds.

B. Size, shape and location

- 1) The combined area of "**Active Recreational Use**" for a facility to qualify for credit is a minimum of three quarters (0.75) acres, or 32,670sf.
- 2) The area for "**Active Recreational Use**" shall take into consideration such factors as size, shape, topography, geology, access and location, and the developer must propose and agree to design and construct the necessary recreational and park facilities and improvements associated with each Element per Chapter 17.35.
- 3) The shape and location shall provide the greatest utility possible to the greatest number of residents of the development. Limited access areas are not recommended and will be calculated accordingly.
- 4) Irregularly shaped pieces of property of less than optimum utility or burdened by topographic considerations that render them unsuitable for "**Active Recreational Use**" will not be accepted.

C. Area calculation:

- 1) shall not include features required to be included by zoning and building codes and other applicable laws, including but not limited to existing easements for other public purpose, yards, patios, paseos, court areas, setbacks, sidewalks, decorative landscape areas required with residential site design, etc.
- 2) Per the building code and fire safety, there is a setback requirement of at least 4 feet from a building.

D. Compliance:

- 1) Must be in compliance with the provisions of the Parks, Open Space and Recreation Goals and Policies of the City General Plan.
- 2) All features and amenities must be in substantial compliance with The Americans with Disabilities Act, Federal, State and Local Regulations, as well as Park Standards, where the Department's determination is final.

E. Maintenance:

- 1) Developer shall supply a covenant to maintain the private on-site parkland and recreational amenities to the City Attorney.
- 2) All furnished areas must remain furnished.
- 3) Maintenance and replacement of items should be contained in the CC&Rs.

Section 3 – INTERNAL (STAFF) REVIEW AND APPROVAL PROCESS

1. PARK & RECREATION DEPARTMENT STAFF REVIEW

A. Landscape design details

- 1) Provide Landscape sheets that indicate the standard specifications and typical details for various park items according to the City of Santa Clara Parks & Recreation Park Amenity & Design Standards, included but not limited to:
 - a. adequate parking;
 - b. electrical/lighting details, light post design;
 - c. fencing design, bollards, attachments & types;
 - d. grading/drainage;
 - e. handicapped access location(s), path of travel;
 - f. irrigation detail-typical pipe schedule plan & profiles, bubblers/shrub/spray heads/timers/remote control system, backflow prevention, recycled/potable water (drinking fountain);
 - g. park signage/rules and entry sign;
 - h. recommended planting list and typical tree planting detail;
 - i. soil profile and turf type recommendations;
 - j. typical pathway dimensions, materials, compaction/composition recommendations, mow band dimensions;
 - k. typical park amenities/product recommendations for picnic benches, BBQ, park bench, playground apparatus;
 - l. utility access and vault locations;
 - m. other (i.e. trail connections).

B. Conditions

- 1) Upon receiving a complete application for a residential development or subdivision, the Director of Parks & Recreation shall determine the conditions necessary to comply with the requirements of parkland dedication as set forth in Chapter 17.35.
- 2) Said conditions shall be proposed to the Approving Authority as conditions of approval for the project.
- 3) All furnished areas included in the private and public park and recreational land must remain furnished and the maintenance & replacement of such items will be contained in an appropriate legally binding document that will run in perpetuity with the land.

C. Additional Steps in the “process”:

- 1) Construction oversight usually provided by Public Works Department engineering staff;
- 2) A punch list development & project review;
- 3) Maintenance/warranty period;
- 4) Title/dedication of parcel to City;
- 5) Acceptance of Project by the City;
- 6) Park dedication ceremony.

Section 4 – PUBLIC DESIGN REVIEW AND APPROVAL PROCESS

1. PUBLIC MEETING #1 – Scaled Drawing and Story Board Submission for Park & Recreation Commission
 - A. Submit three park conceptual options. These should provide preliminary draft “Concept A”, “Concept B” and “Concept C” (or more) and include the words on each of the sheets *“Preliminary Conceptual Design for discussion purposes only.”*
 - B. Plans should be 24 x 36 (D-Size paper) and follow City preferred format: “D-Size Project Title Sheet” and “D-Size Project Title Block”. Request these documents if needed.
 - C. These will be needed two weeks prior to the meeting date to be reviewed internally and potentially also with the City Manager’s Office. To help the discussion and anticipate questions of what, where, dimensions, setbacks, and materials contemplated, the sheets and/or presentation (power point is an option) should include design elements in “call out boxes” (line from the location in the design to the picture/example of what is contemplated), and the relative size(s) and square footage of the features.
 - D. The Commission will ask questions and make comments, followed by public comment.

2. PUBLIC MEETING #2 – Scaled Drawing and Story Board Submission for Park & Recreation Commission (potentially a community meeting)
 - A. Present further design improvements and show how design solutions were incorporated to address comments and priority concerns.
 - B. May address construction and maintenance costs. Commission makes recommendation regarding preferred design option to City Council.

3. PUBLIC MEETING #3 – Scaled Drawings & Story Board Submission for City Council
 - A. Tight presentation of 3-5 slides covering project background, initial design criteria, Conceptual Renderings, public input process and request for Council Input/Approval.
 - B. Will work with staff to incorporate into City Council report format and timelines.

4. Construction Design Plans Required:

Plans should be 24 x 36 (D-Size paper) and follow City preferred format: “D-Size Project Title Sheet” and “D-Size Project Title Block”. Request these documents if needed.

5. As-Built Plans – official record drawings that document what was actually constructed - to be submitted to Parks & Recreation Department upon final sign-off.